

# Dual-Vision™ XC4

## User Manual

### Installation & Operating Instructions



**APRIL 2018**

**90-21 144<sup>th</sup> Place, Jamaica, New York USA 11435**

**Phone: 800-227-2095**

**[www.roscovision.com](http://www.roscovision.com)**

**Version 5.6**

©2018 Rosco® Vision Systems, All Rights Reserved  
Specifications and details are subject to change without prior notice.  
Patent Pending

# TABLE OF CONTENTS

For the latest version of the User Manual please visit [www.roscovision.com](http://www.roscovision.com)

|   |           |
|---|-----------|
| <b>Safety Instructions</b> .....                      | <b>4</b>  |
| <b>Introduction</b> .....                             | <b>5</b>  |
| <b>Package Contents</b> .....                         | <b>6</b>  |
| Kit Part #: DV440.....                                | 6         |
| <b>Features</b> .....                                 | <b>7</b>  |
| DVXC4.....  | 7         |
| DATA RETRIEVAL OPTIONS.....                           | 7         |
| DV-Pro5 Player (See page 20) .....                    | 8         |
| <b>Recorder Detail</b> .....                          | <b>9</b>  |
| <b>Installation</b> .....                             | <b>10</b> |
| Power wiring diagram.....                             | 10        |
| PDC (Power/Data Control) Module Installation .....    | 11        |
| Installing Mounting Bracket (DV402) .....             | 12        |
| Mounting the Recorder Unit (DV401) .....              | 13        |
| Mounting DV405 Modem & Antenna (Option) .....         | 15        |
| Application Note for DV440, DV405, DV508 .....        | 16        |
| <b>DVXC4 Operation</b> .....                          | <b>17</b> |
| Drive Recording .....                                 | 17        |
| Continuous and Event Recording.....                   | 18        |
| <b>Recorder Removal &amp; SD Card Retrieval</b> ..... | <b>19</b> |
| <b>DV-Pro5 Player Program</b> .....                   | <b>20</b> |
| Introduction to DV-Pro5 (Standard Version) .....      | 20        |
| Install DV-Pro5.....                                  | 21        |
| DV-Pro5 Home Screen .....                             | 22        |
| <b>Camera System Setup and Configuration</b> .....    | <b>23</b> |
| General Settings.....                                 | 24        |
| Channel Settings .....                                | 25        |
| Event Settings .....                                  | 26        |
| Server Settings.....                                  | 27        |
| Remove SD Card from PC & Install into DVXC4 .....     | 28        |
| Setting Up and Analyzing G-SENSOR Data.....           | 30        |
| G-SENSOR Event Examples in DV-Pro5.....               | 31        |
| Backing Up Video Files to Your PC (Import).....       | 32        |
| Conversion of Video To AVI.....                       | 33        |
| Vehicle Location Map .....                            | 34        |
| Format SD Card using DV-Pro5 .....                    | 35        |
| <b>SD Card Maintenance</b> .....                      | <b>36</b> |

**DVCV4 Hardware Technical Specifications ..... 37**  
**Engineering Drawings ..... 38**  
**Application Notes..... 38**  
**Troubleshooting..... 39**  
**AUX Cameras (Optional)..... 40**  
**Spare Parts ..... 41**  
**Commercial Warranty ..... 42**

# Safety Instructions

## STOP!

To ensure proper operation please read this User Manual before installation and operation. Failure to follow this safety notice may cause a malfunction and will void the warranty.

## **IMPORTANT**

**FOLLOW PROPER SHUTDOWN PROCEDURE PRIOR TO UNLOCKING DVXC4 FOR SD CARD REMOVAL.**

(Refer to **p. 19**)

**BEFORE REMOVING DVXC4 FROM MOUNT, USE SUPPLIED KEYS TO UNLOCK THE RECORDER. (Refer to **p. 19**)**



**ALWAYS USE THE “EJECT” FEATURE ON YOUR PC PRIOR TO REMOVING ANY SD CARD FROM YOUR PC. FAILURE TO**

**DO SO WILL CORRUPT THE SD CARD. (Refer to **p. 27**)**

## **CAUTION**

**THE FOLLOWING ACTIONS WILL VOID WARRANTY AND MAY CAUSE AN ELECTRICAL SHORT CIRCUIT**

DO NOT:

- Clean recorder with any liquids
- Insert foreign materials into the Dual-Vision XC4 device
- Attempt to disassemble, repair or modify the product
- Use cables, SD cards or fuses that are not provided by or recommended by Rosco®

## **NOTE**

**GPS** The Dual-Vision XC4 Mounting Bracket must be mounted on the windshield in order to have direct line-of-sight to the sky for reliable GPS satellite signal acquisition.

**SD CARD** The SD card must be reformatted periodically using the DV-Pro5 menu---Refer to “SD Card Formatting” section on page 35.

# Introduction

Dual-Vision XC4 by Rosco provides HD recording of exterior/interior video, and continuously logs vehicle travel data. Mounted on the windshield, Dual-Vision XC4's twin cameras capture wide-angle views of the forward exterior field of vision and the driver/passenger compartment. Privacy concerns may be addressed through several means, including disabling of interior audio recording.

Data is recorded in a continuous loop, with oldest video erased by more recent video. The compact system can hold many hours of data before any over-writing takes place. An internal GPS antenna enables capture of vehicle location, speed, and direction. Important "Events" such as excessive G-Force and speeding are placed in special protected files along with video segments identified by the driver as being important.

All the data is stored in proprietary files located on a removable SD card. Video, audio, location information, and G-force data may ONLY be reviewed by accessing the contents of the SD card using Rosco's proprietary DV-Pro5 Player software. The software is provided at no additional cost to the end-user, and there are no follow-up fees for use or updating of the Player by authorized users. Critical videos may be converted to standard media-player formats for transmission to legal or administrative offices.

**Security:** Dual-Vision XC4 is a commercial grade product designed to be used in a variety of applications. The Security Lock discourages unauthorized removal of the SD card. Installation via hard-wire connection to a vehicle's electrical system discourages tampering and provides recording capability even after the engine has been shut off.

**DV-Pro® Fleet Management Software:** Dual-Vision XC4 kits are provided with the standard DV-Pro5 Player software. For more advanced needs, Rosco has developed DV-Pro5-ADS software, an exclusive fleet management software program for managing multi-vehicle video recordings and database management.

Contact Rosco Vision Systems or your authorized dealer for more information.



## **IMPORTANT**

***If you have a problem printing this document, please download and install the latest version of Adobe Reader:***

<http://www.adobe.com/support/downloads/product.jsp?platform=windows&product=10>

# Package Contents

Kit Part #: DV440



**DV401: 2CH  
RECORDER UNIT**



**DV402: WINDSHIELD  
MOUNTING BRACKET**



**DV453: SD CARD 64GB SD  
card (DV453) – changed from  
32GB to 64GB since mfg. date  
code 1703**



**DV404: PDC MODULE**  
*Power and Data Control Module*



**DV441: EXTERNAL  
DRIVER EVENT BUTTON**



**DV443: HARDWARE KIT incl.,  
Temporary & Permanent VHB Tapes  
with Primer Pen, Allen Wrench, Two  
Keys, Four Screws for PDC mounting**

**Additional Items possibly included with your order:**

- DV405: 4G Cellular Module
- DV406: Wi-Fi Module
- DV407: Wi-Fi Patch Antenna
- DV408: 4G Cellular Antenna
- DV412: Wi-Fi MIMO Screw Mount Antenna
- DV415: Wi-Fi MIMO Antenna Extension Cable (1 meter)

# Features

## DVXC4

- HD Quality Video Recording
- 720p Forward View Camera, 960H Interior Camera
- Optional Auxiliary Cameras
- High accuracy built-in GPS confirms location several times per second
- Built-in G-sensor accelerometer
- Locking mounting bracket protects SD card
- Tamper resistant
- Compatible with current and future high-capacity SD memory cards
- Extended hours of recording time per high capacity SD card
- Built-in infrared LED's for excellent night interior view



## DATA RETRIEVAL OPTIONS



Manual SD card removal



Wi-Fi download to dedicated fleet-owned server



Remote download and/or live streaming video via cellular transmission



## Video Playback and Data Management

Dual-Vision XC4 captures video/audio/GPS/sensor data and creates proprietary files, which are only readable when viewed within Rosco DV-Pro5 program, included at no additional charge with each recorder. DV-Pro5 is provided in one of two versions, depending on the end-user's data management scenario.

### DV-Pro5 Player (See page 20)

- Proprietary video files
- Advanced playback control – frame speed & volume control, video zooming, full screen playback
- Quad-view playback windows
- Easy video management (organized on local storage media for easy retrieval)
- Historical GPS tracking with Google Street & Satellite Map Integration
- Graphical display of accelerometer values
- Built-in SD card formatting
- Platform for configuring per-vehicle Recorder settings
- Conversion of propriety files to .avi video files for sharing with authorized parties



# Recorder Detail

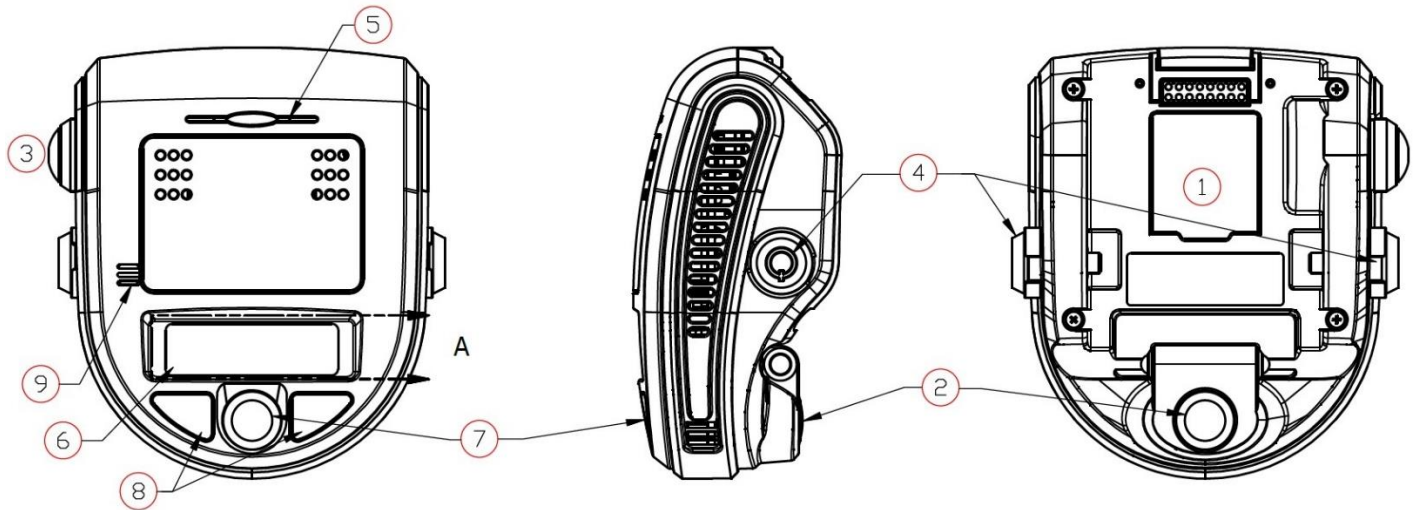

|  |                                |
|--|--------------------------------|
| 1. SD Card Slot (Authorized access only) | 6. LCD Display                 |
| 2. Front Camera (Exterior View)          | 7. Rear Camera (Interior View) |
| 3. Driver Event Button                   | 8. Infrared Illuminators       |
| 4. Windshield Mount Push Locks           | 9. Microphone                  |
| 5. Audible Alarm Signal                  |                                |



6  
DETAIL A  
SCALE 2 : 1

# Installation

The complete installation requires a Recorder (equipped with cameras and microphone), a Recorder Windshield Mount (equipped w power/video/data harness), and a PDC module. The PDC (Power Data Distribution) Module is connected the vehicle's power system. The PDC's role is to provide regulated power and external video/data connections to the Dual-Vision™ XC4 Recorder. See [page 38](#) for a basic system connection diagram.

- Each vehicle has its own system and features. Please refer to your vehicle's manual for details.
- Turn the ignition key off while installing the cables and device.
- Select a secure protected location for the PDC module.
- **Make sure to connect Ground wire first!**

## Power wiring diagram

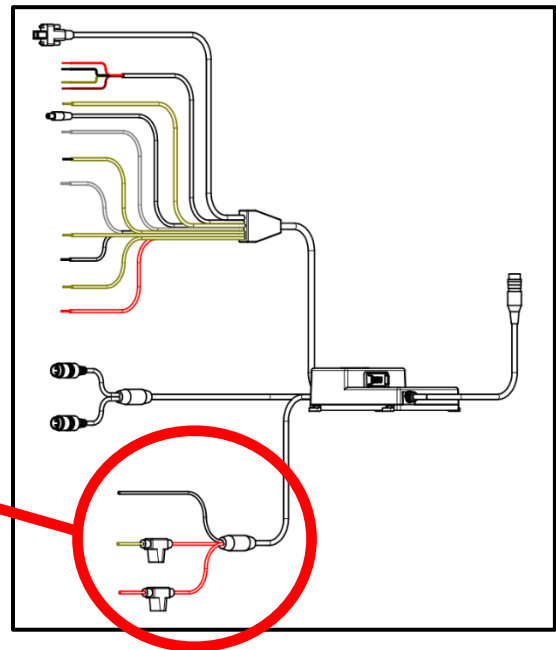
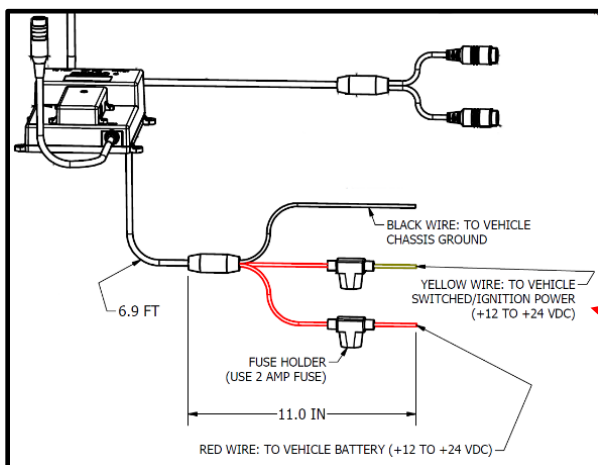

## IMPORTANT NOTE FOR INSTALLER

The DVXC4 Power Data Control Module (PDC) contains three wires—red, black, and yellow. The yellow wire triggers Parking Surveillance by sensing the moment when the driver shuts the ignition. Parking Surveillance typically provides recording at a lower frame rate for a pre-configured time period. Parking Surveillance options are noted in the Configuration menu. In situations where a manager chooses not to utilize this option, the system must be still wired properly to function. Use the Configuration choices in DV-Pro5 to disable the Parking Surveillance Mode (see [page 23](#)).

Installers must be certain that the yellow wire is secured to the vehicle fuse block at a terminal which will be at a zero-voltage state when the vehicle ignition key is OFF. A typical location on a fuse block would be the ACC port for cigarette-lighter power. Please refer to the vehicle manual and fuse block schematic to identify best locations for DVXC4 power/ignition/ground wire connection points. Zero-voltage state should be verified using a voltmeter prior to installation.

The PDC module includes internal circuit protection against high current or voltage spikes. It is very important, however, for the professional installer to include appropriate external fuses.

# PDC (Power/Data Control) Module Installation

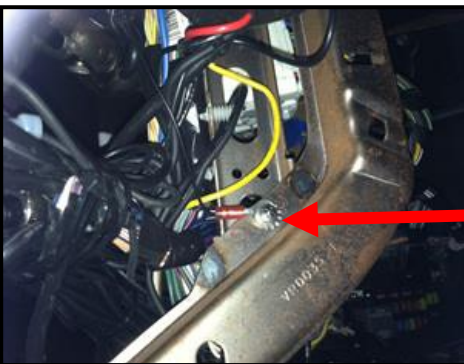

2. Unpack the DVXC4 box and prepare all the parts & tools necessary for installation.
1. Find the location of the fuse box in the vehicle. Identify the vehicles constant wire and connect to the RED POWER wire. Locate the vehicles ignition wire and connect to the YELLOW IGNITION wire. Make your connections using the Military splice (Poke & Wrap) & secure with a Zip Tie.
3. Identify approximate Dual-Vision™ XC4 Recorder location on windshield. See [page 12](#). Confirm sufficient cable length available to connect PDC to the Dual-Vision™ XC4 Recorder. Remove the A-Pillar cover and insert the cable at the gap between ceiling and windshield.
4. After determining that PDC location is appropriate, trim the cable length as necessary, and make the following connections:
  - a. Connect the BLACK WIRE (GROUND -) with ring terminal to a chassis ground.
  - b. Connect the RED wire (POWER +) to a constant – powered source which will remain live after the ignition is turned OFF.
  - c. Connect the YELLOW wire (IGNITION) to an IGN power source.

**EXAMPLE:**

*Ground Wire Ring  
Terminal connected to the  
vehicle chassis ground*

5. Find a location for the Driver Event Button that can be easily accessed by the driver. Avoid locations where the button may be inadvertently pressed, such as by the driver's knee. Remove the adhesive film and attach the button. Connect the Driver Event Button plug to the Data Cable Harness attached in the PDC Module. Secure all loose wires and components with cable ties and reinstall vehicle panels.

# Installing Mounting Bracket (DV402)

1. **IMPORTANT:** Installation should only be done when ambient temperature is within 50°F-100°F (10°C-38°C) to allow proper curing of mounting adhesive pads.
2. Determine the proper Dual-Vision™ XC4 Recorder location on windshield. Typically, the Recorder is mounted behind and slightly below the mirror.
3. Make sure the interior-facing camera and the LCD display are not obstructed by the mirror. Different vehicle/windshield combinations allow many other acceptable mounting locations. The goal is always to minimize forward-viewing obstruction while enabling optimal recorded images. Dual-Vision™ XC4 Recorder should be level both vertically and horizontally.
4. Clean the windshield glass with commercial glass cleaner. Using the adhesive pad marked “temporary”, attach Mounting Bracket to windshield and press firmly.
5. After mounting, use the provided Hex Key to loosen the Hex Bolt on the Mounting Bracket. Adjust Mounting Bracket to a fully vertical position and re-tighten the Hex Bolt.

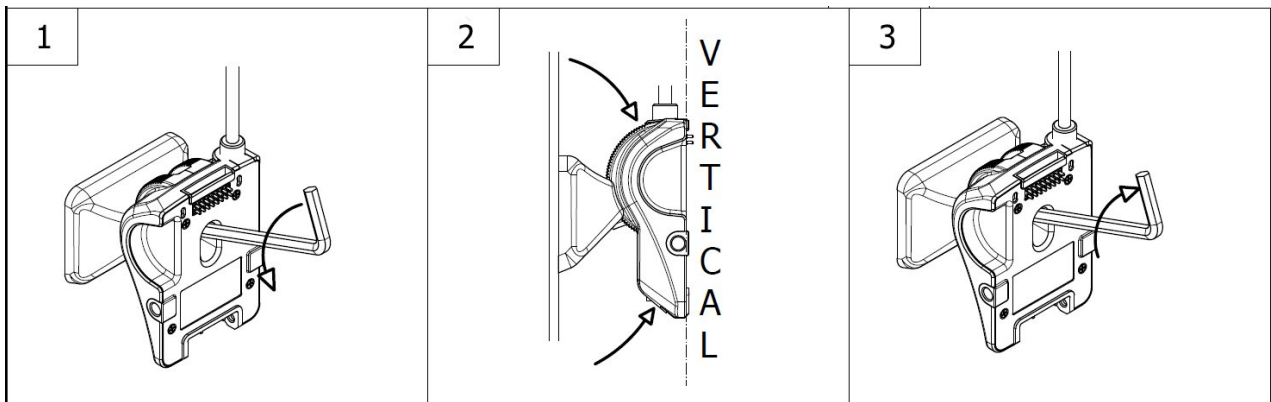

6. Connect Recorder cable to the PDC Module. For most vehicles, this connection will be made within the overhead space, and will be covered by the headliner. For additional security, or for installations on very large windshields, it is advisable to enclose the connection within a heat shrinkable tube or other protective cover, per your installer's suggestion.



# Mounting the Recorder Unit (DV401)

1. Install the SD Card as shown below. Hook the Recorder onto the top of the bracket and firmly push the bottom of the Recorder to engage it into the Mount, confirmed by an audible “click”:  
(See below)

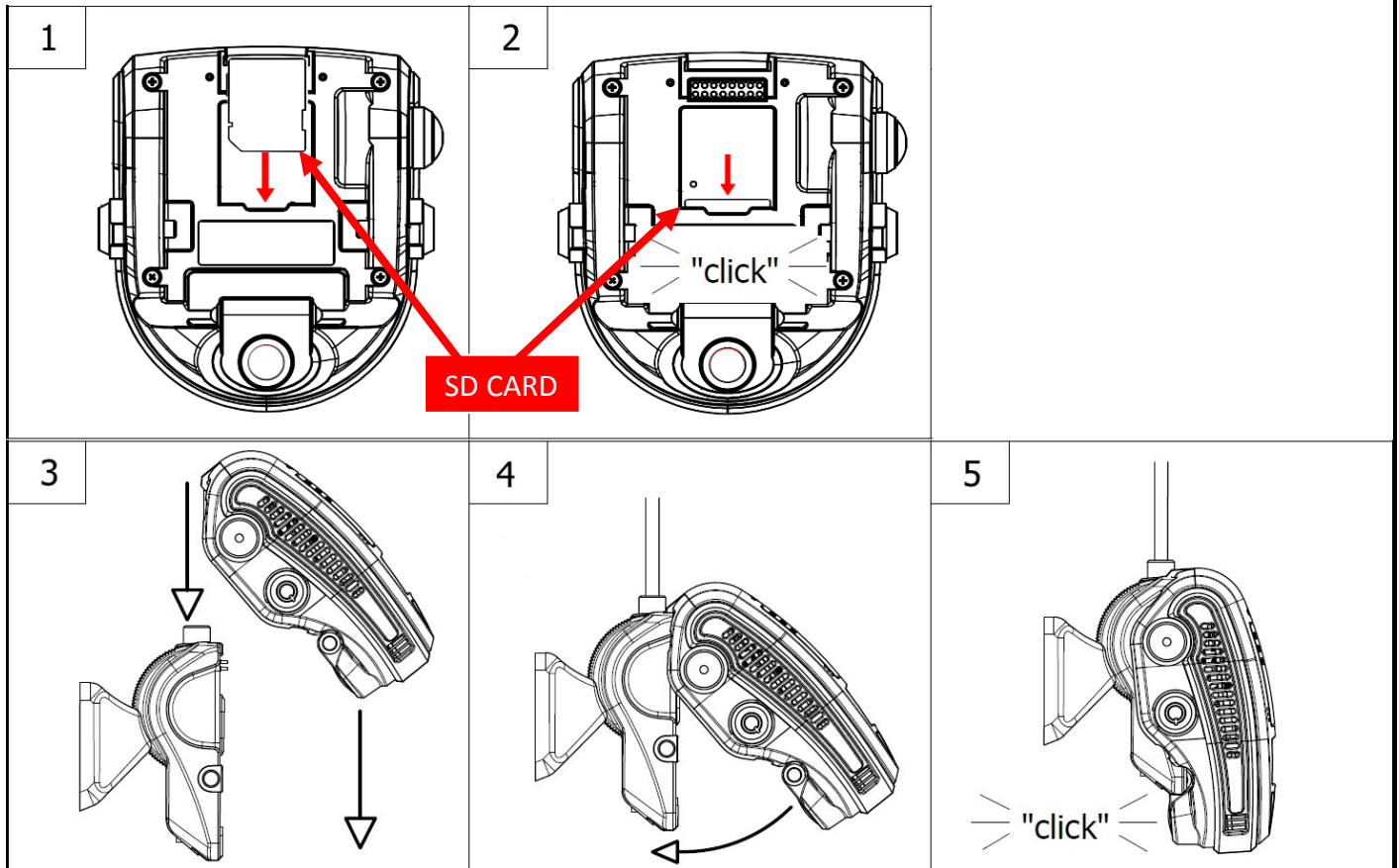

Properly Assembled Recorder & Mount:



Interior View



Left Side View



Right Side View

2. Lock the recorder into position by pressing the two side-locks in, prior to turning on Power.
3. Turn the vehicle ignition on, and check that the Recorder LCD display lights up to confirm proper electrical connection. Confirm that the LCD displays “GPS”, “CH1”, “CH2”, “REC” and

time of day. “GPS” might not display if the vehicle is not outdoors. For the first time, it may take up to 2 minutes for the Recorder to acquire a satellite signal and display “GPS”. (see below)



4. Allow Recorder to run for a few minutes. Turn the vehicle ignition off and confirm the LCD display dims/blinks slowly, indicating Parking Surveillance Mode. Refer to [p.19](#) to safely remove the SD card.
5. Review SD card to confirm GPS acquisition and camera views. (See Pages [20-35](#) for Player software installation and video playback instructions). Open DV-Pro5 on a PC, then insert the SD card into the PC's SD card slot or reader. At that time, the files on the test SD card will pop up. Click to view test video. If the video recording indicates that Recorder location is not acceptable, adjust the bracket angle and/or re-position bracket, and test again. If the Recorder placement is acceptable, proceed to the next step for permanent installation.
6. Use a Nylon Pry Tool to carefully peel off the temporary adhesive pad and remove the Mounting Bracket. Clean the windshield. Break open the glass primer ampoule and apply a layer of 3M Primer on the surfaces of both the Windshield Mounting Bracket and the windshield. Let the primer dry for at least two minutes. Attach the permanent adhesive pad to the Windshield Mounting Bracket, and then carefully press the assembly onto the windshield, holding it in place with pressure for about 30 seconds.
7. Do not re-mount Recorder yet. After permanently attaching the Mounting Bracket, allow at least 2 hours at room temperature to make sure that the adhesive properly cures. Then make sure there is an appropriate SD card inserted into the back of the Recorder, and proceed to “clip-in” the Recorder body into the Mounting Bracket. You are now ready to begin recording.

## **IMPORTANT**

*Installation of permanent mounting should only be done when windshield is at room temperature. Allow 2-4 hours for adhesive bond to cure properly before operating vehicle.*

# Mounting DV405 Modem & Antenna (Option)

For applications involving communication with the Dual-Vision DVXC4 recorder, a modem (Rosco part #DV405 or other) is supplied to enable connection and data transfer while driving. There are several modems offered by Rosco depending on the broadband carrier and geographical location, but the most popular is Rosco DV405 stand-alone 4G LTE modem working on the Verizon network.

Rosco pre-configures each Dual-Vision DVXC4 (part #DV440) unit and matches it to a pre-tested working modem prior to shipping the kits to the fleet customer. Therefore, when DV440, modem and antenna are installed properly, everything should work like a plug-and-play installation.

Most important is to confirm that the connections between the DVXC4's base unit, called the PDC (Power/Data Control module, Rosco part # DV404) and the modem are properly secure. A USB connection is made (see figure XX below) and secured with the supplied zip-tie. Once the PDC and modem are securely installed, the antenna is connected (see Fig 6). Make sure to connect MIMO1 to the PRI port and MIMO2 to the DIV port (see Fig 5). For most applications, Rosco supplies our part #408 Windshield Glass Mounted Antenna. Run the antenna cable up to above the dash, and attach the antenna to the windshield, in any location providing a clear "view" to the sky- see suggested locations in photos below (see Fig 1, Fig 2 and Fig 3).

If mounting the antenna on the vehicle's windshield is problematical, the antenna may be attached to the top of dashboard as a second choice- however, the cellular wireless communication performance will likely be degraded. It is therefore not recommended, but there are cases where this location will provide sufficient signal strength. Never install the antenna under the dashboard or in the glove compartment, that will result in communication problems.

For vehicles requiring other types of antennas, we do offer roof-mount options, please contact your Rosco representative for more information.



Fig 1. Left Side Windshield Mount Antenna (Interior View)



Fig 2. Left Side Windshield Mount Antenna (Outside View)



Fig 3. Bottom Side Windshield Mount Antenna (Interior View)



Fig 4. If the antenna wire is too long, bundle it round and use a couple of zip ties to secure the cable



Fig 5. Connect MIMO1 to PRI port & MIMO2 to DIV port in the modem



Fig 6. Use a zip tie (TIE1001) and secure the USB cable on PDC

# Application Note for DV440, DV405, DV508

PDF Drawing Number: AN\_DV440\_DV405\_DV408

**NOTES:**

1. 4G MODEM (ITEM 5): CONNECT TO USB TYPE A PORT ON DVXC4 PDC, ITEM 1.
2. 4G CELLULAR ANTENNA (ITEM 4):
- MIMO 1: CONNECT TO "PRI" ON 4G MODEM, ITEM 5
- MIMO 2: CONNECT TO "DIV" ON 4G MODEM, ITEM 5

| ECO# | REV | DESCRIPTION | DATE      | AUTHOR    |
|------|-----|-------------|-----------|-----------|
|      | A   | NEW RELEASE | 1/23/2017 | Emily.Lin |

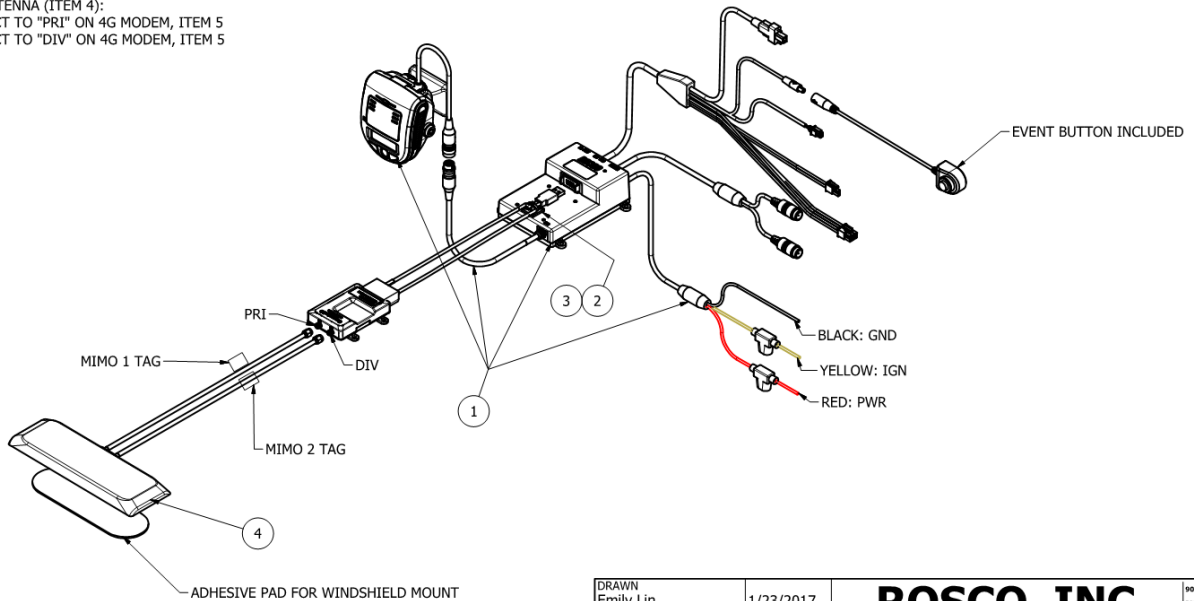

| ITEM | QTY | PART NUMBER | DESCRIPTION   |
|------|-----|-------------|---|
| 1    | 1   | DV440       | DVXC4 ADVANCED, 4 CHANNEL HD PLUS WIFI AUTOMOTV VIDEO RECDR   |
| 2    | 1   | TIE1201     | CABLE TIE MOUNT,ADHESIVE,4 WAY 3/4"W,,.06"THICK,BLACK,PLASTIC |
| 3    | 1   | TIE1001     | CABLE TIE,NATURAL NYLON,5/8" 4"L,1000/PKG,PANDUIT# PLT-1M-C   |
| 4    | 1   | DV408       | 4G LTE CELLULAR ANTENNA FOR WINDSHIELD MOUNT, DVXC4           |
| 5    | 1   | DV405       | 4G LTE VERIZON USA MODEM FOR DVXC4, W/ USB CABLE & SIM CARD   |

|  |                 |
|--|-----------------|
| DRAWN<br>Emily.Lin   | 1/23/2017       |
| CHECKED  |                 |
| THIS DRAWING AND/OR ITS RESPECTIVE CAD FILE IS THE PROPERTY OF ROSCO, INC. AND MAY NOT BE TRACED, COPIED OR OTHERWISE USED IN ANY MANNER WITHOUT THE WRITTEN AUTHORIZATION OF ROSCO INC. |                 |
| ALL DIMENSIONS IN INCHES UNLESS OTHERWISE SPECIFIED  |                 |
| ANGULAR TOLERANCES: ± 1°   |                 |
| SURFACE FINISH: RA 1.6   |                 |
| TOLERANCES: XX ±   |                 |
| 0" - 1.99"   | 0.001" - 0.005" |
| 2.00" - 11.99"   | 0.002" - 0.015" |
| 12.00" - 23.99"  | 0.003" - 0.020" |
| 24.00" - 47.99"  | 0.004" - 0.025" |
| 48.00" & UP  | 0.005" & UP     |

|  |                                |   |
|--|--------------------------------|---|
| <b>ROSCO, INC</b>  |                                | 99-23 14479 PL<br>JAMAICA NY 11435<br>(718)526-2661 |
| TITLE<br>APPLICATION NOTE FOR DV440 4G CELLULAR INSTALLATION WITH DV405 AND DV408. |                                |   |
| SIZE<br>B  | DWG NO<br>AN_DV440_DV405_DV408 | REV<br>A  |
| SCALE  | SHEET 1 OF 1                   |   |



# DVXC4 Operation

## Drive Recording

- Your DVXC4 is supplied with an SD card pre-configured with factory default settings (see page 24-27). Insert the SD card into a PC and add identifying information. Of course, you may also change the values of any configurable setting as desired. Make sure to “SAVE” as instructed on page 27.
- After re-inserting the SD card into the back of the Recorder, proceed to “click-in” the Recorder into the Mounting Bracket as previously described.
- Turn the ignition on. “boot” will appear on the LCD display indicating that the Recorder is initializing. Approximately 30 seconds after powering on, the LCD will briefly display “F1XX” indicating the firmware version, and a chime will sound indicating that initialization is complete. Although GPS still may not be active, recording begins when “REC” is displayed.



- Within two minutes of start (assuming outdoor location), the GPS signal will be acquired, and the GPS icon will light up. Subsequent vehicle starts will acquire GPS signal significantly faster than the original start-up. GPS location data will be continuously analyzed, and each video file will contain embedded location, speed and direction data.

***NOTE:*** When the vehicle is in motion, the LCD displays vehicle speed. When the vehicle comes to a complete stop, the LCD speed indicator will display the time after a few seconds. The option to show speed can be disabled by changing the SD card configuration (See Page 24)



# Continuous and Event Recording

## Continuous (Normal) Recording

- When the ignition is OFF, Dual-Vision™ XC4 Recorder remains powered for an additional 5 seconds to finish recording. If Parking Surveillance is ON, LCD Display will show “PARK” icon on and count-down the parking time in minutes and the LCD will be blinking and dimming slowly and the recording will be continued until the parking time ends.
- Dual-Vision™ XC4 creates proprietary files (identified as “.nvr” files) which contain video, audio, and tracking data. Proprietary .nvr files will only playback on DV-Pro5 Player program.
- Continuously recorded .nvr files are NOT protected against overwriting. When the capacity of the SD Card has been reached, the oldest non-Event files are overwritten.

## Event Recording

- Event Recording – When a preconfigured speed or G-sensor values are exceeded, or when Driver Event Button is pressed, an “EVENT” is created. That is, the .nvr file associated with that Event is marked and protected against overwriting.
- Event files may be locked or unlocked via the SD Card configuration (See Page 26).
  - If Event Locking is enabled, new event files will be created until they fill up about 25% of the SD card space. Those first event files will never be overwritten and the DVXC4 LCD will display “FULL”. However, the remaining 75% of the card will continue to record normal continuous video and overwrite as needed. New event files will be treated as normal continuous video files and will be overwritten by normal continuous files. In order to remove the locked files, the card will need to be formatted (See page 35).
  - **By default, Event Locking is disabled** in the SD card configuration. New event files will be created until they fill up about 25% of the SD card space. The newest event files will then overwrite the oldest files (a FIFO queue, first-in first-out). **It is strongly recommended that event locking is left disabled** in order to preserve the newest event files for the maximum amount of time without user intervention.

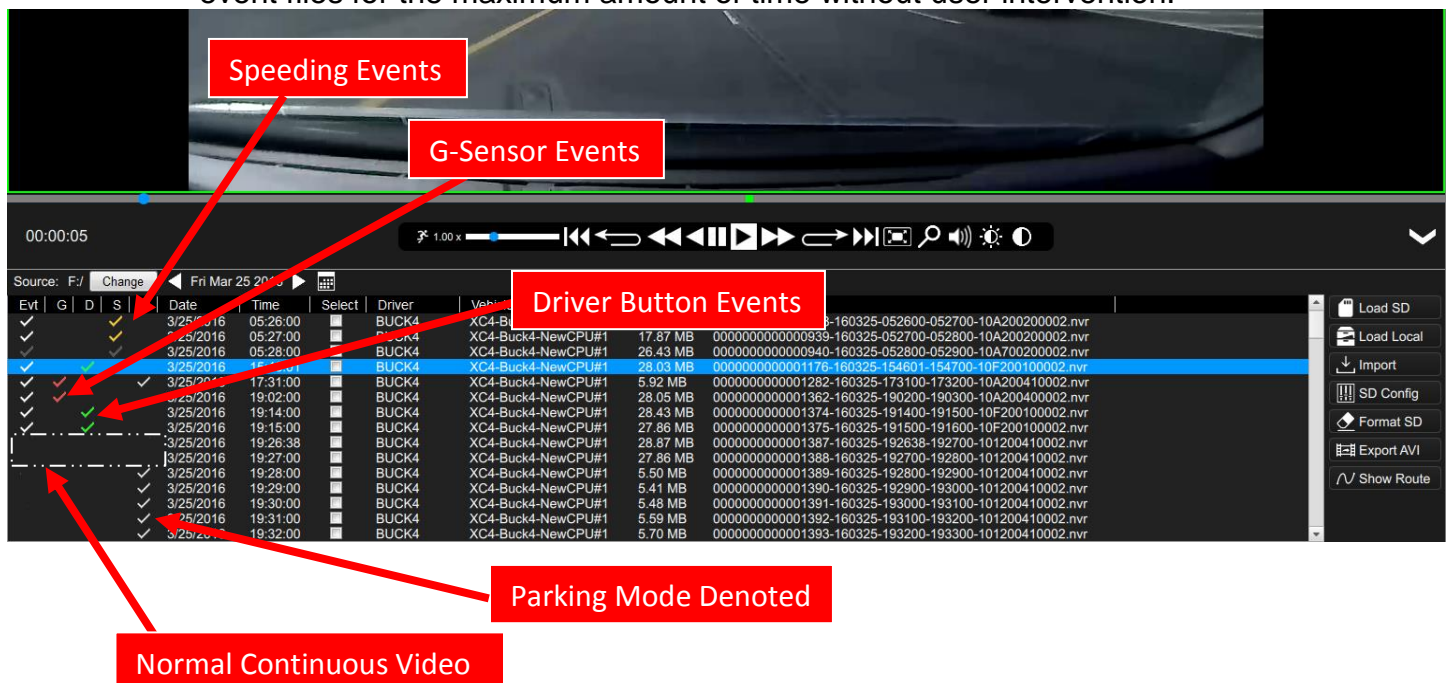

# Recorder Removal & SD Card Retrieval

**IMPORTANT: FOLLOW PROPER SHUTDOWN PROCEDURE.  
RECORDER MUST BE COMPLETELY POWERED OFF  
BEFORE DETACHING RECORDER OR REMOVING SD CARD.**

***ALWAYS*** power off the vehicle prior to removal of SD Card from Dual-Vision™ XC4 Recorder.

- If parking surveillance mode is OFF, turn ignition off. It is safe to remove the SD card after the Recorder's LCD display turns off.
- If parking surveillance mode is ON, turn ignition off and wait for few seconds until the LCD display begins blinking/dimming. Then press and hold the Driver Event Button for at least 5 seconds until the LCD indicates "SHUT", and then goes dark. It is now safe to remove the recorder and SD card as shown below.

**BEFORE REMOVING RECORDER FROM MOUNT, USE THE SUPPLIED KEYS TO UNLOCK THE RECORDER (STEP 1 BELOW).**

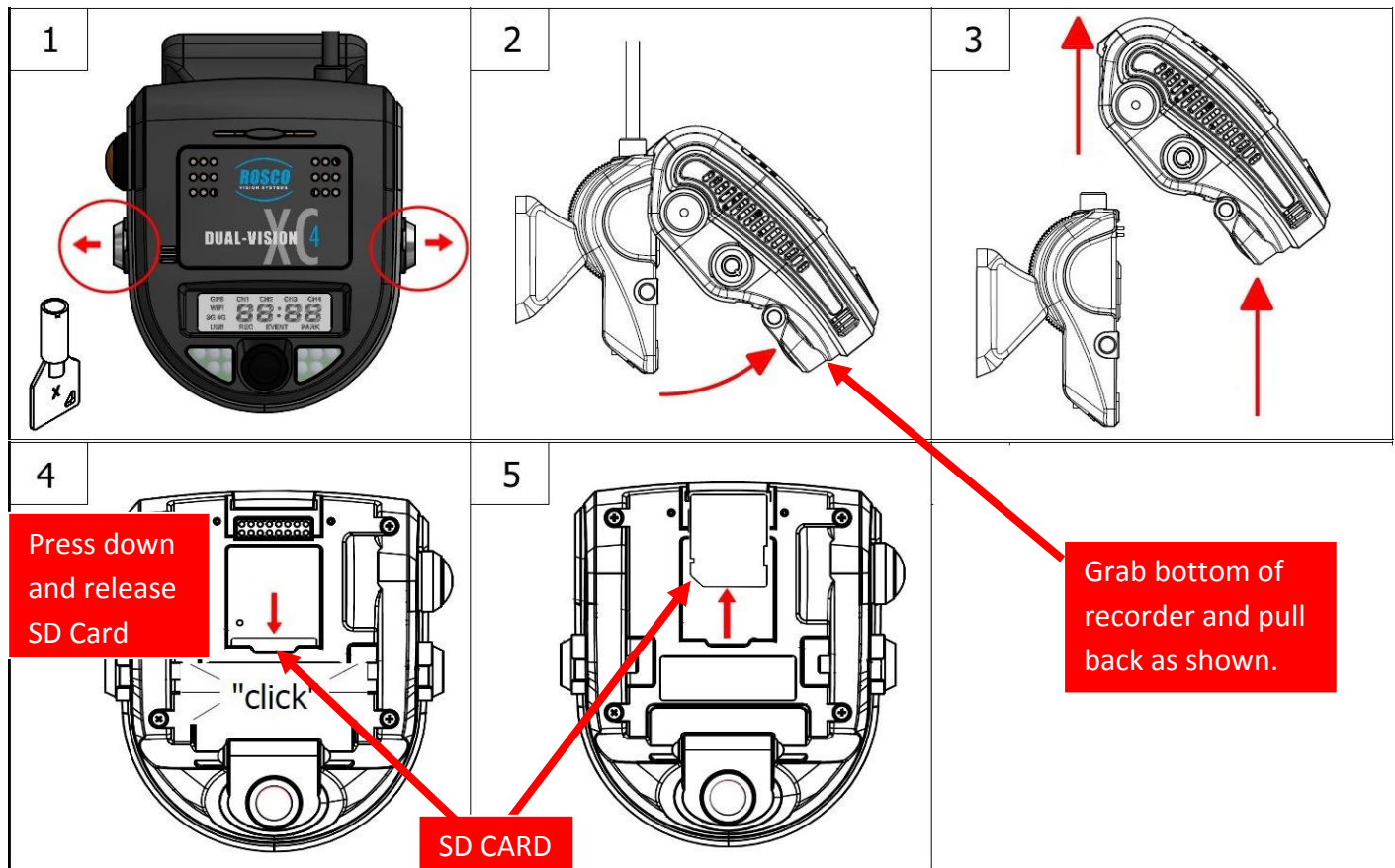

# DV-Pro5 Player Program

## Introduction to DV-Pro5 (Standard Version)

Note: This manual will only cover the Standard version of DV-Pro5. See the separate “DV-Pro5 Advanced User Manual” in order to use DV-Pro5 with advanced wireless features such as WIFI/ADS and cellular 4G LTE streaming/cloud services.

Use the Standard version of DV-Pro5 to play video files off the DVXC4 SD Card. The player can simultaneously show 4 channels of video, display a live map, and show speed, G-sensor data, etc. The player can also be used to format SD cards, setup user preferences for recording (SD Card Configuration), back-up SD card files to a computer (Import), or export video to .avi files.



***NOTE:*** DV-Pro5 is compatible with most PC operating systems (Windows 7, 8 and 10). It is currently not compatible with Mac OS-X or Unix-based operating systems.

# Install DV-Pro5

Your SD card comes pre-loaded with the files required to install DV-Pro5 on your PC. If those files are not available, please contact Rosco Vision Systems and we will send you the required files.

To install “DV-Pro5” from the SD card, insert the card into PC and click “open folder to view files”. Then click “DV-Pro-Setup-Basic-5.0.0.xxx.exe” (xxx denotes the latest version) to begin the installation.

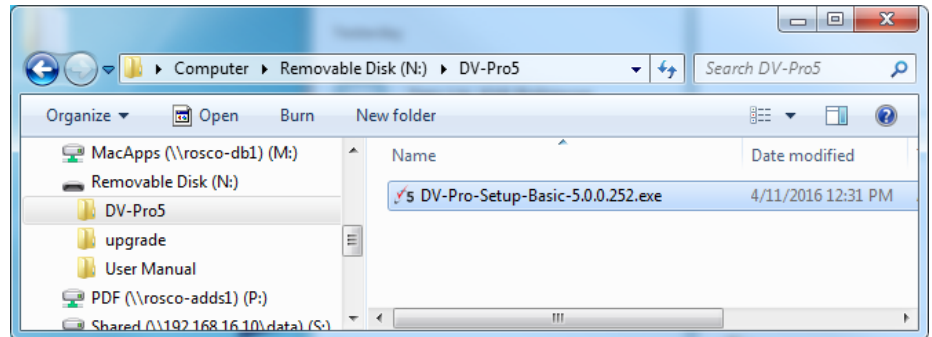
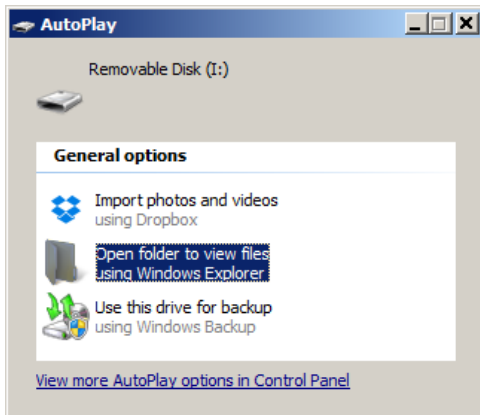

If the below “User Account Control” window opens, click “Yes”. Click “Next” on the subsequent windows to complete the installation. By default, the program will install to C:\Program Files (x86)DV-Pro5, but this can be changed if desired.

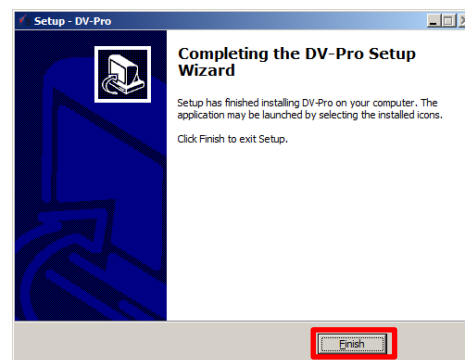
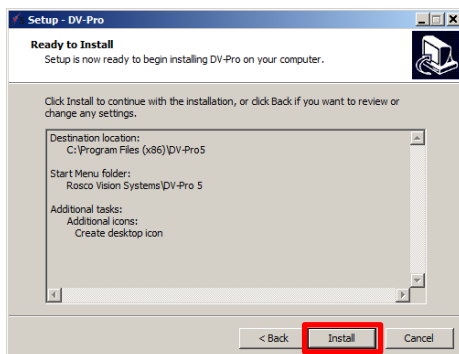
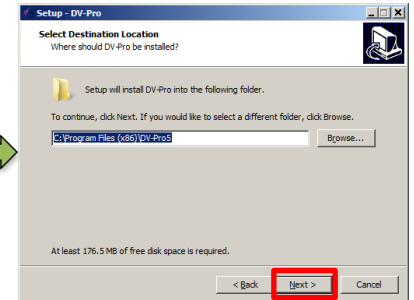
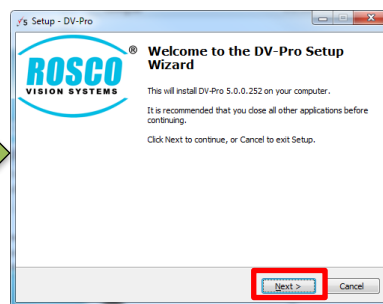
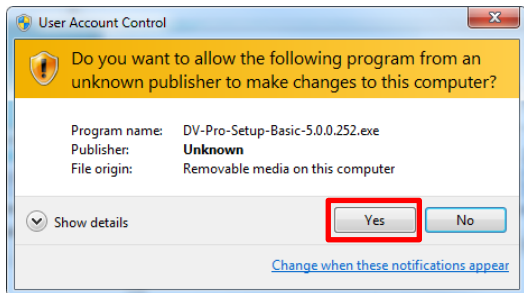

# DV-Pro5 Home Screen

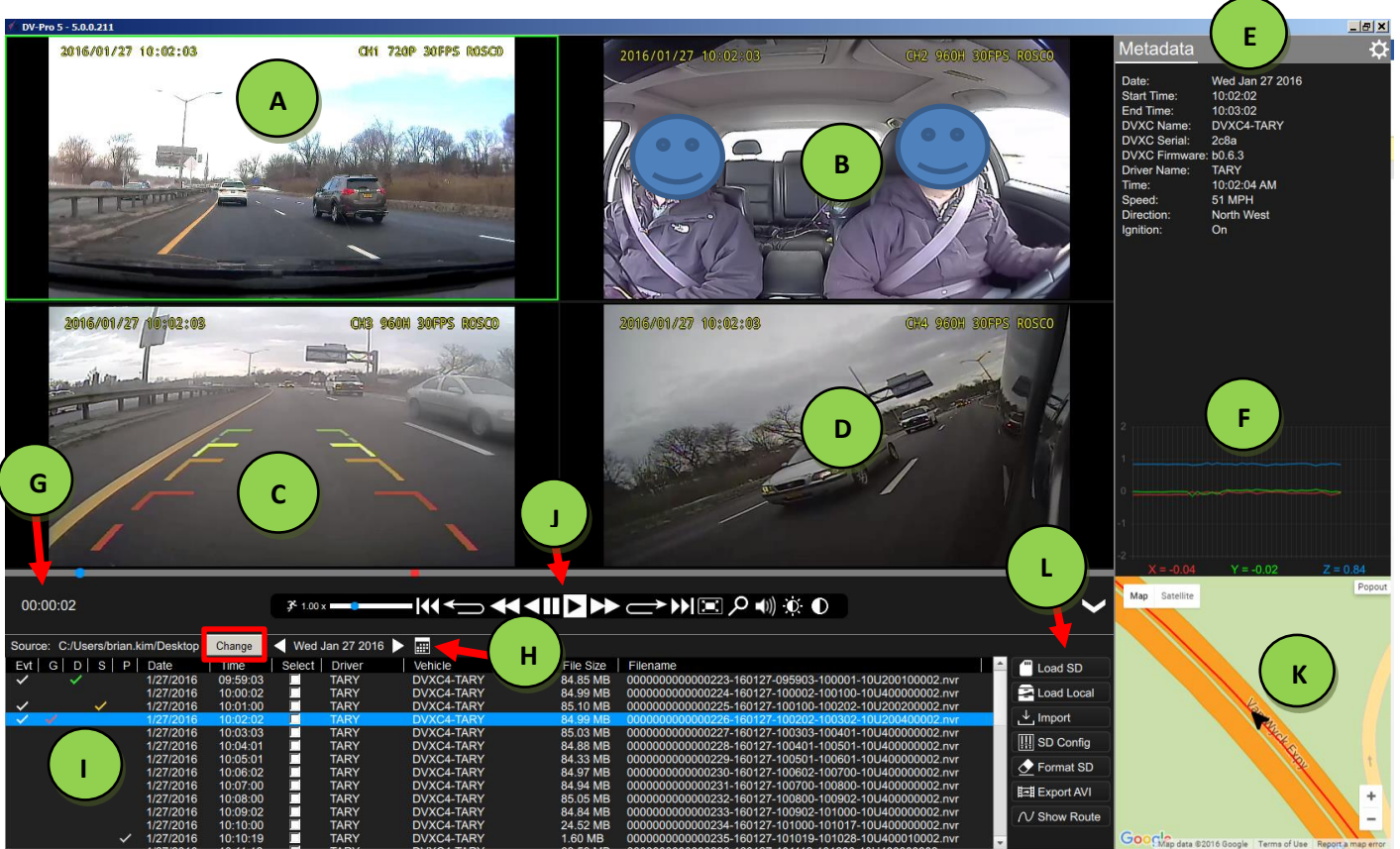

|  | NAME | DESCRIPTION       |
|--|------|-------------------|
|  | A    | Forward Camera    |
|  | B    | Interior Camera   |
|  | C    | AUX Camera 1      |
|  | D    | AUX Camera 2      |
|  | E    | Metadata          |
|  | F    | G-Force graph     |
|  | G    | Playback Time     |
|  | H    | Calendar          |
|  | I    | File List         |
|  | J    | Playback Menu Bar |
|  | K    | Map               |
|  | L    | File Menu Tree    |

|  |  |
|--|--|
| <p><b>Load SD:</b> Click to load video files from the SD card into the file list</p> <p><b>Load Local:</b> Click to load videos from a local directory of the PC/Network Drive/etc. DV-Pro5 will automatically choose the directory where SD files were last saved to (see "Import" below).</p> <p><b>Import:</b> Click to save video files to a local PC directory/network drive etc</p> <p><b>SD Config:</b> Click to review or configure recording preferences</p> <p><b>Format SD:</b> Click to format the SD card</p> <p><b>Export AVI:</b> Click to Export and save video as an .AVI file</p> <p><b>Show Route:</b> Select multiple files and click this button to show the vehicle's route on the map</p> |  |
|--|--|

# Camera System Setup and Configuration

**Introduction:** Use the DV-Pro5 program to configure all recording settings on the Dual-Vision XC4 Recorder. The program will write a configuration to the SD card, and the DVXC4 recorder will automatically use the configuration from the SD card when the vehicle is powered on.

Insert the SD card into the PC and open DV-Pro5. You may click on the shortcut icon for “DV-Pro5” on your Desktop PC screen. Click on the System Setup configuration button (  ). The below window will then appear and you can change the recording and event flagging options as needed. 4 pages of settings are available: **General Settings, Channel Settings, Event Settings, and Server Settings.**

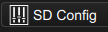
**Locate SD Card in DV-Pro** (If not automatically loaded): On any page of the settings, click the “Source” button in the bottom and go to “Removable Disk” where the SD card is located and highlight “config.txt” file and click “Open”. Then the current configuration settings in the SD card will automatically populate in the configuration pages.

**Save:** Review and change settings in the configuration menus as needed and click “Save”. The new configuration will be saved in the SD card. Insert the SD card into the Recorder, mount the recorder on the bracket and power on the vehicle. The Recorder will automatically use the new configuration for recording video, registering events, etc.

**Save As:** Click to back up the SD config.txt file to a PC directory. Navigate to the desired directory, and type a filename (example: “config\_backup.txt”). Click Save.

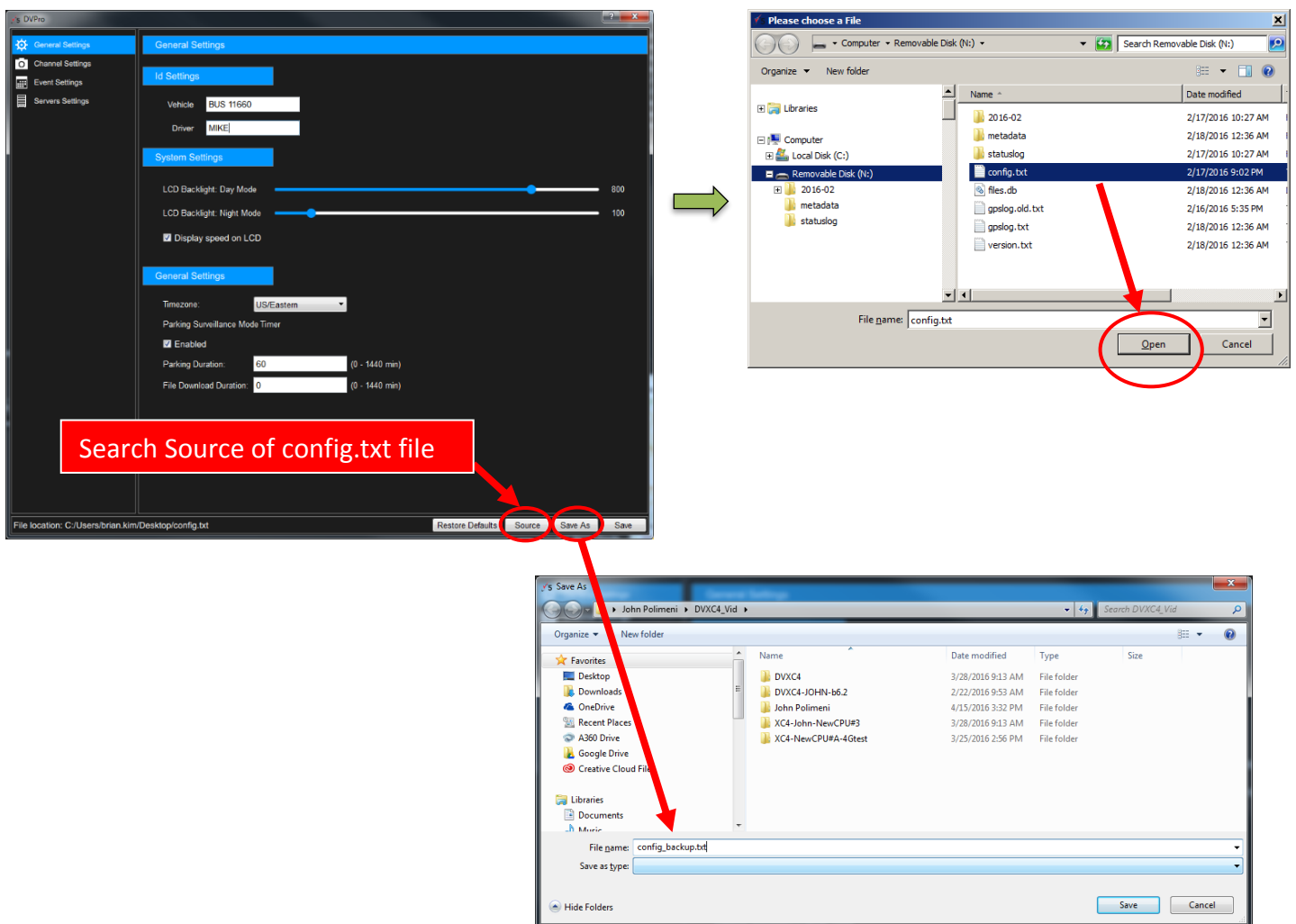

# General Settings

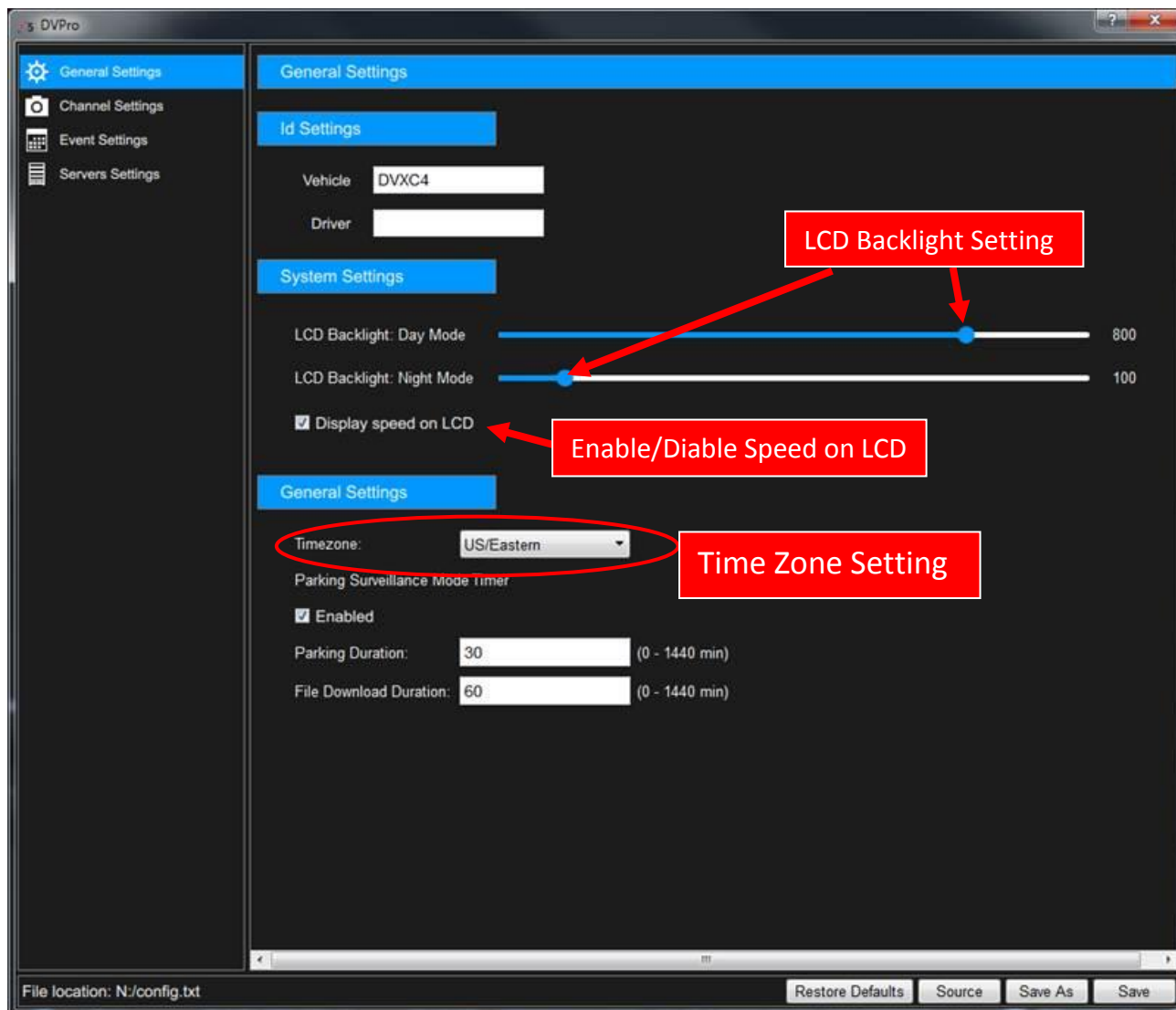

| CONFIGURATION ITEM       | DESCRIPTION   |
|--------------------------|---|
| <b>ID Settings:</b>      | Enter a vehicle number or nickname, and Driver name. These names will appear in the video file list in DV-Pro5 and will be automatically used to name video folders when importing video to your PC (see page 32).  |
| <b>System Settings:</b>  | <p><b>LCD Backlight Day/Night Mode:</b> This adjusts the brightness of the numerical LCD display on the actual DVXC4 recorder unit. Set a brightness for day and night. The DVXC4 will automatically detect daytime and night time/dark conditions and adjust the display brightness automatically.</p> <p>If "<b>Display speed on LCD</b>" is checked, the recorder display will show the speed of the vehicle while moving and display time when stopped. If this is unchecked, the recorder will constantly display time instead.</p>  |
| <b>General Settings:</b> | <p><b>Time Zone:</b> Choose the correct time zone according to where the vehicle is predominantly operated. The recorder will automatically increment/decrease an hour according to Daylight Savings Time.</p> <p><b>Parking Surveillance Mode Timer:</b> Check the box to enable the DVXC4 to record surveillance video while the vehicle is parked and powered off. If this box is unchecked, then the DVXC4 will turn off when the vehicle ignition is turned off.</p> <p><b>Parking Duration:</b> Adjust the duration of Parking Surveillance mode. This value can be set up to 24 hours (0-1440 min).</p> <p><b>File Download Duration:</b> (<b>For DV-Pro5 Advanced Version ONLY</b>) This is the time allotted for WIFI download of video from the recorder after the vehicle ignition has been turned off. This setting is independent of the parking surveillance timer above.</p> |



# Channel Settings

Prior to recording video for the first time, ensure the Channel Settings are configured on the SD card so that the proper frame rate and video quality is set. The below screen shot contains the factory default settings. **Note 1:** Changing FPS and Quality Settings on each channel will impact the video file size. The lower numbers in these settings will result in lower file size, thus yielding more hours of driving video on the SD card. **Note 2:** Channel 3 and 4 (AUX cameras) are disabled by default. If they are enabled and no cameras/video feeds are connected, the recorder will show **“ERR 5”** upon startup.

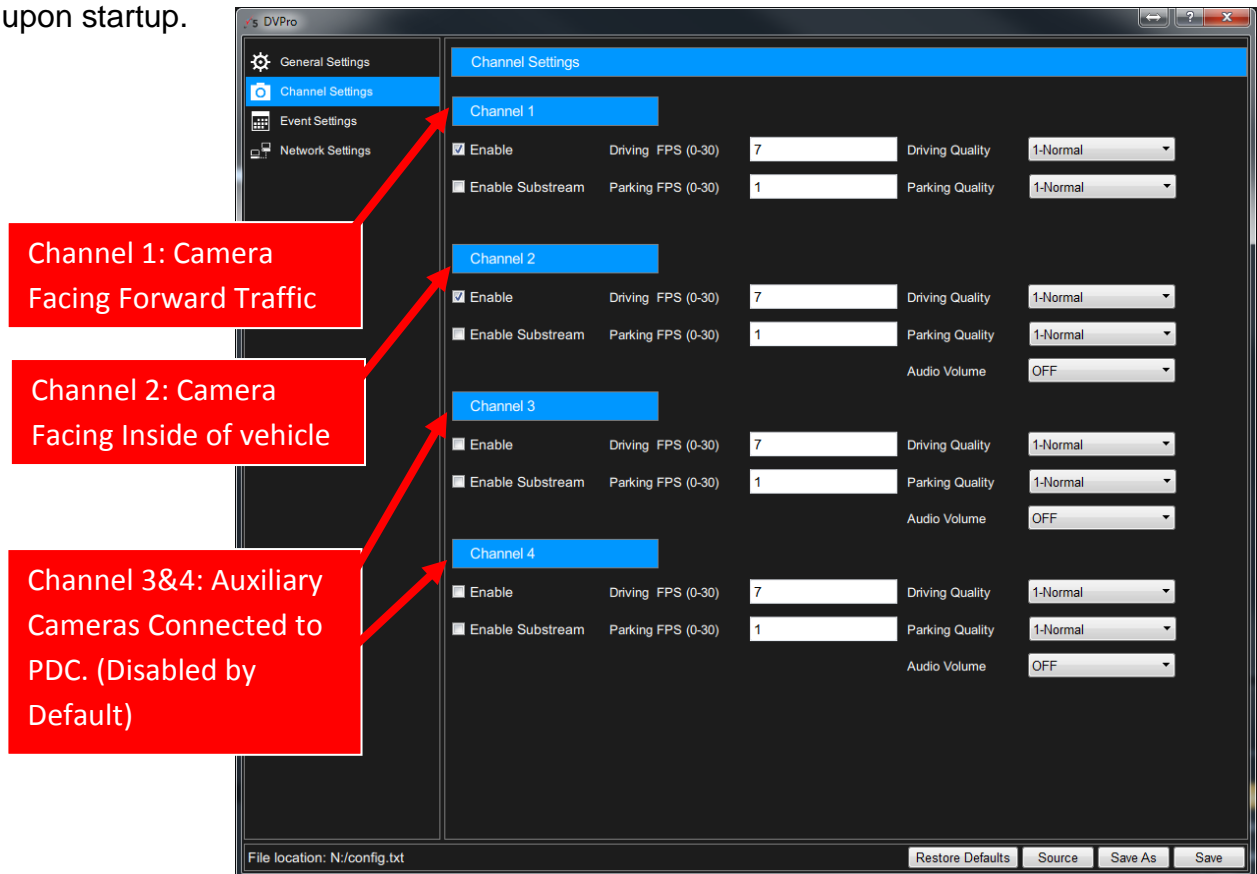

| CONFIGURATION ITEM                  | DESCRIPTION   |
|-------------------------------------|---|
| <b>Enable</b>                       | Check to enable or un-check to disable video recording on that channel.   |
| <b>Main FPS – Frames/Second</b>     | Frame rate while the vehicle is powered on. 7 FPS is satisfactory for most applications   |
| <b>Main Quality</b>                 | Video quality while the vehicle is powered on. 1-Normal is satisfactory for most applications   |
| <b>*Parking FPS – Frames/Second</b> | Frame rate while the vehicle is powered off and the recorder is in parking surveillance mode. 1 or 2 FPS is satisfactory for most applications. |
| <b>Parking Quality</b>              | Quality while the vehicle is powered off and the recorder is in parking surveillance mode. 1-normal is satisfactory for most applications.      |
| <b>**Audio Volume</b>               | Adjust audio volume levels from OFF to 4(Max) on Ch2, Ch3, Ch4. Level 3 is satisfactory for most applications. Ch3, Ch4 audio default is OFF.   |
| <b>Enable Sub stream</b>            | Check to enable or un-check to disable streaming video over the 4G cellular network.  |

**\*NOTE:** \*Parking Surveillance: settings are independent from the values selected for normal driving mode Configuration. \*\*Audio Volume: Ch1 has no audio. The recorder uses Ch2 to record audio. To hear audio in DV-Pro, the Channel 2 video window must be clicked/highlighted, click volume icon in the playback control bar and adjust desired volume.

# Event Settings

This page configures the way videos are flagged as events. All videos flagged as events are saved to a separate portion of the SD card. This way, they are generally preserved much longer than regular video files (up to a year depending on how often they are generated). Care must be taken to adjust these settings for optimal incident or driver behavior reporting.

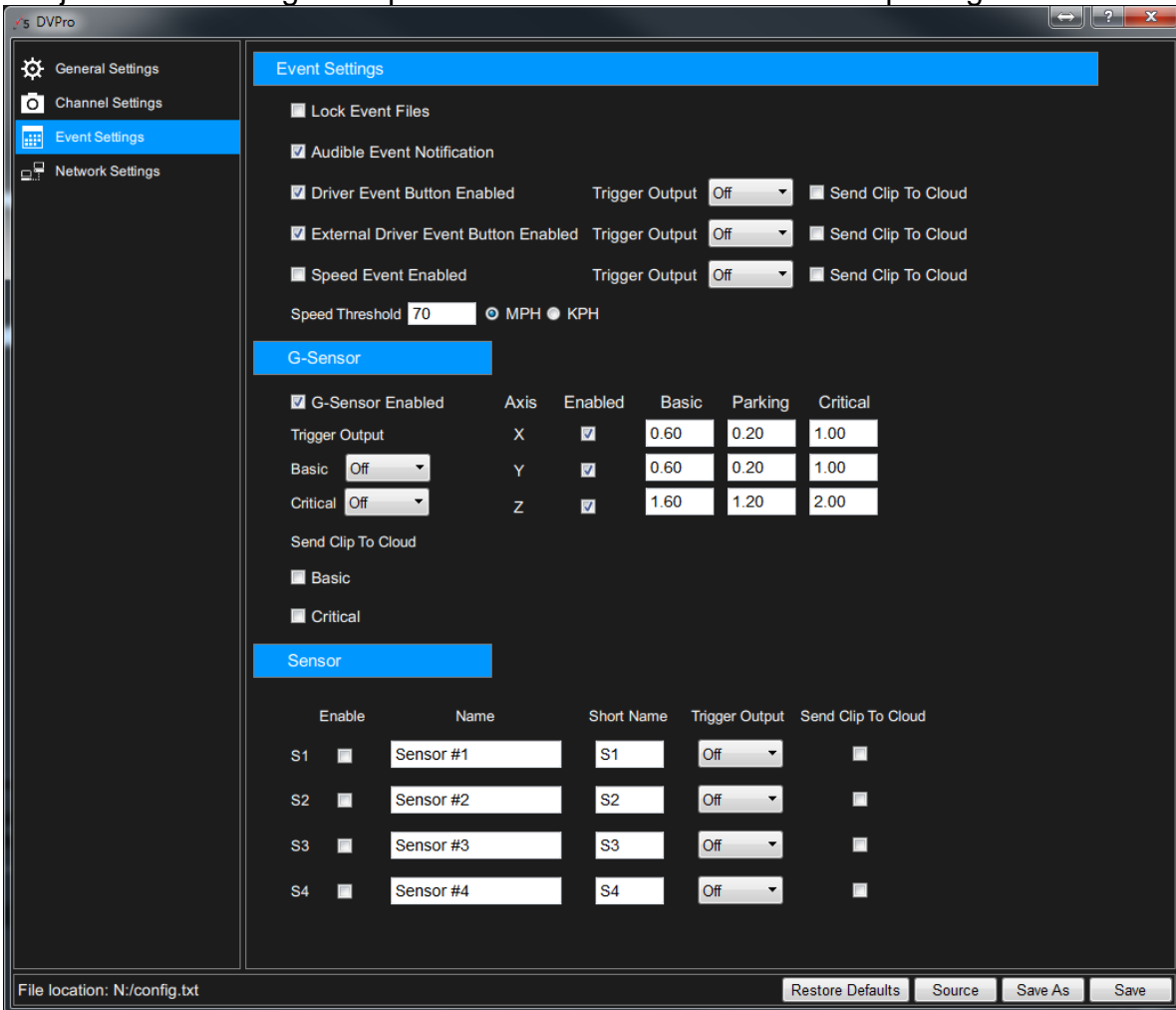

| CONFIGURATION ITEM      | DESCRIPTION  |
|-------------------------|--|
| <b>Event Settings:</b>  | <p><b>Driver Event Button:</b> enable/disable the driver event button located on the recorder itself. The driver hits this button to manually flag an event.</p> <p><b>External Driver Event Button:</b> enable/disable the button. Same as the above driver event button except connected via a cable.</p> <p><b>Speed Event:</b> enable/disable events automatically triggered by the speed of the vehicle</p> <p><b>Speed Threshold:</b> Set the speed at which the speed events are automatically triggered.</p> <p><b>Trigger Output:</b> Choose an output in order to send a 12V signal to either the Out 1 or Out 2 white wires coming from the advanced PDC module whenever that particular event occurs (see page 38). These outputs are set to off by default.</p>                               |
| <b>G-Sensor:</b>        | <p>The DVXC4 contains a G-sensor to sense vehicle motion (stopping, acceleration, etc). Adjust these settings for optimal event flagging based on motion/impacts etc.</p> <p><b>Axis Enabled:</b> Enable whether that axis is used at all. X= Left/Right Y= Front/Back Z= Up/Down 1= the force due to gravity, so the Z axis should always be set greater than 1. 0= no force at all.</p> <p><b>Basic &amp; Critical:</b> These G-sensor events are triggered while the vehicle is powered and moving. Critical values should be set higher than basic to denote more intense accelerations.</p> <p><b>Parking:</b> G-sensor events while the vehicle is off and the recorder is in parking surveillance mode. Set these values lower in order to sense disturbances to the vehicle while it's parked.</p> |
| <b>Sensor Settings:</b> | <p>Sensor Inputs 1-4 correspond to the 4 yellow wires on the advanced PDC (see page 7). These wires will sense 12V inputs to trigger Events. Input examples are a seat belt confirmation, a door open switch, etc.</p>   |
| <b>Others:</b>          | <p>We strongly recommend leaving the "Lock Event Files" selection unchecked. This is to allow the newest event files to replace the oldest event files in the case that the event file portion of the SD card is full.</p>   |

# Server Settings

This page is for configuring wireless video file download and streaming from the DVXC4 recorder to a server or cloud. For basic DVXC4 installation with SD-Card video file transfer only, leave all options on this page unchecked (see below screenshot). For optional RoscoLive Cloud Service installation with 4G modem, Rosco pre-configure the server settings for customer. For Wi-Fi option, configure the Wi-Fi network settings to connect to a local Wi-Fi Access Point. After changing/reviewing the configuration settings as desired, **click “Save” and exit** the configuration menu.

The screenshot shows the DVPro configuration interface with the following settings:

- Network Settings**
  - Wi-Fi Network Settings**
    - Wifi Enabled
    - WiFi SSID: DVXC440
    - WiFiAuth Mode: Wpa2Psk
    - IP Address Type: DHCP
    - WiFi Password: [masked]
    - IP Address: 0.0.0.0
    - Subnetmask: 0.0.0.0
    - Default gateway: 0.0.0.0
  - RoscoLive Settings**
    - 4G Mobile Network Enabled
    - Tracking Enabled
      - Host: tracking.roscocloud.com
      - Port: 5600
      - Device ID: 11328361
      - Report Interval: 5
      - Alarm Report Interval: 5
    - Cloud Storage Enabled
      - Host: storage.roscocloud.com
      - Port: 5601
      - Fleet Token: 1232569b
      - Send Local Events \*Enable Send Local Events for RoscoLive Cloud Storage, disable for Geotab
    - Live Video Enabled
      - Host: streaming.roscocloud.com
      - Port: 5604

File location: G:/config.txt

Buttons: Restore Defaults, Source, Save As, Save

# Remove SD Card from PC & Install into DVXC4

Upon completion of any of the following:

- Reviewing/managing video files
- Updating DVXC4 configuration
- Adding “upgrade” folder to SD card
- Reformatting SD card

Exit DV-Pro5, and follow proper SD card ejection procedure. **Before removing the SD Card from your PC, open a Windows Explorer window, right click on the SD Card (usually labeled “Removable Disk”) and click “Eject”.** Wait for Windows to confirm by showing a “Safe to Remove Hardware” balloon, and then remove the SD card.

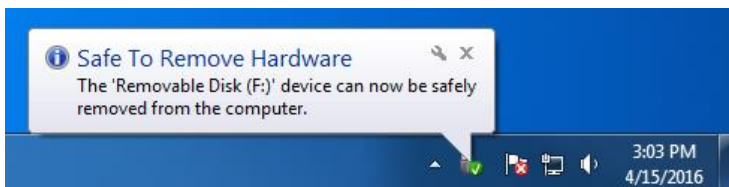
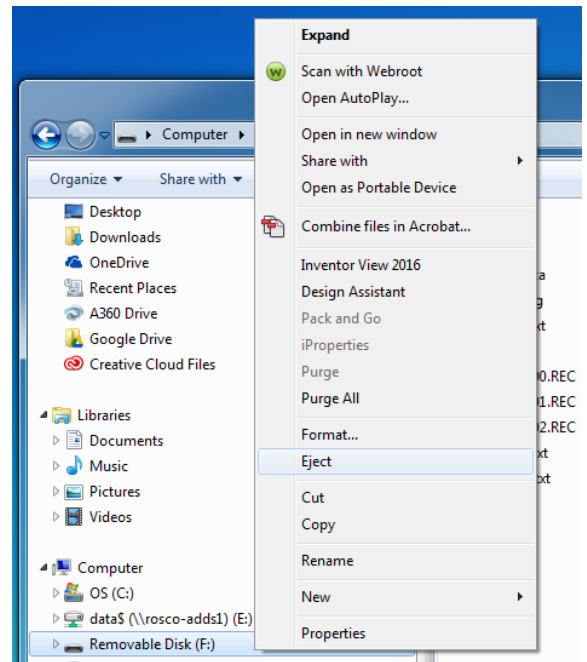

You may now insert the SD Card into the DVXC4 recorder unit as shown on Page 13. You are now ready to turn on the vehicle and begin recording video.

# Video Playback Instructions

1. To playback video, turn off the vehicle and remove the SD card from the DVXC4 recorder unit according to the instructions on Page 19. Insert the SD card into your PC and open DV-Pro 5.
2. Select a video file from the file list. If no video files appear in the list, click the “change” button to choose a different video file source.
3. Select the location (hard drive, external storage, or SD card) where the recorded data is stored and choose folder with “date” such as “2015-11” then click “Select Folder” to open video files.
4. When the video files are listed on DV-Pro player screen, Select and double click a video file in the list to play video.

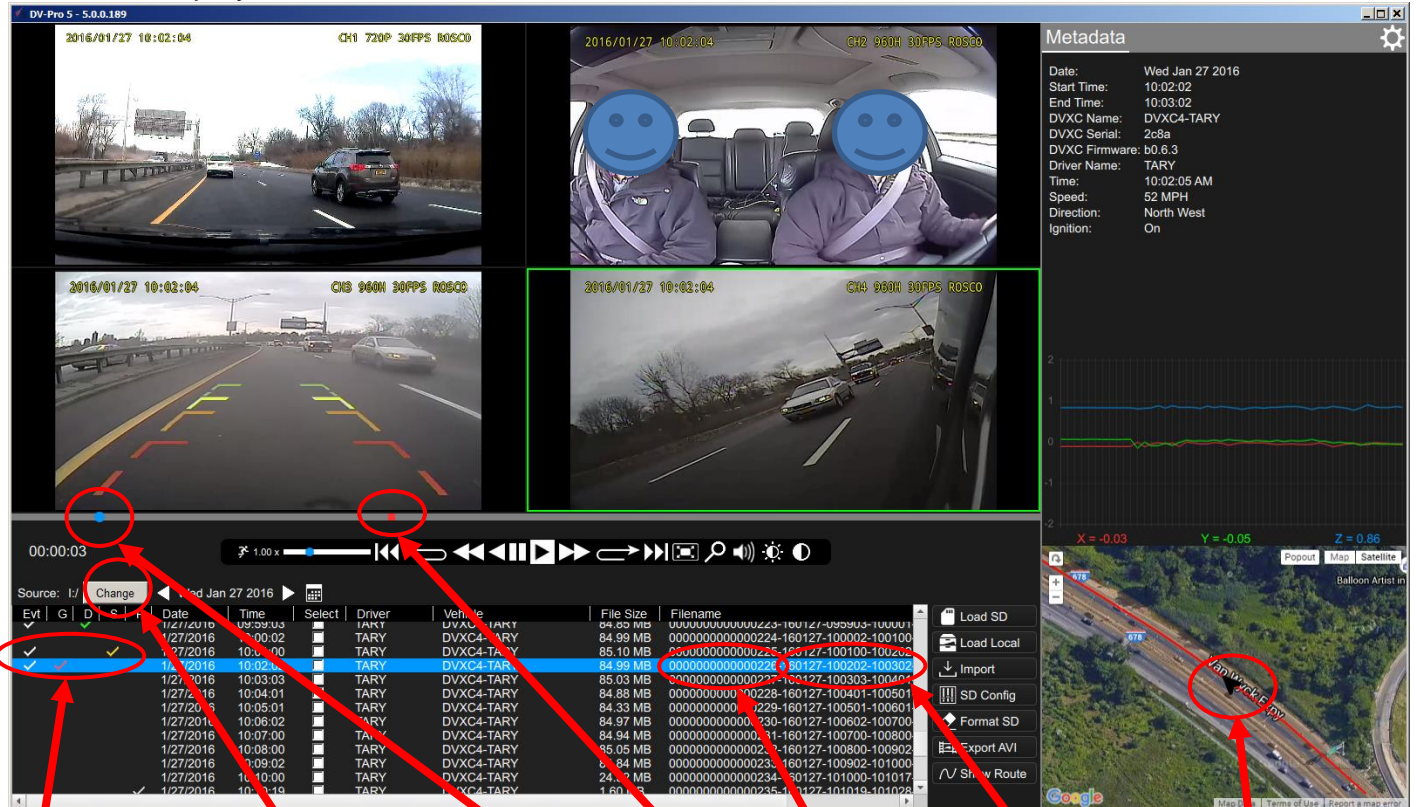

Displays the type of recorded Events (G-Sensor, Driver Button, Speed)

Change video file source

Point of video playback

Point and duration of an Event

File name of video

Date and time when the video was recorded

Location of vehicle (Avail. when PC connected to Internet)

| EVENT TYPE                | DESCRIPTION   |
|---------------------------|---|
| <b>SPEED Event (S)</b>    | Indicates when the vehicle exceeds pre-configured speed limit. Shown as a yellow check mark in the file list and as a yellow bar on the video progress bar.                                 |
| <b>BUTTON Event (D)</b>   | Indicates activation of Driver Event Button. Shown as a green check mark in the file list and as a green bar on the video progress bar.   |
| <b>G-SENSOR Event (G)</b> | Indicates when vehicle experienced sudden acceleration, deceleration or rapid side-to-side movement. Shown as a red check mark in the file list and as a red bar on the video progress bar. |
| <b>PARKING Mode (P)</b>   | Indicates which videos are recorded during Parking Surveillance Mode. Shown as a white check mark in the file list.   |

\***NOTE:** Click menu bar to sort by file name, record time or event type

# Setting Up and Analyzing G-SENSOR Data

The G-Force sensor detects changes in directional forces affecting the vehicle. The Dual-Vision XC4 Player displays G-force data in a graphical format, and creates Events when those forces exceed supervisor-set values. One may interpret the data as follows:

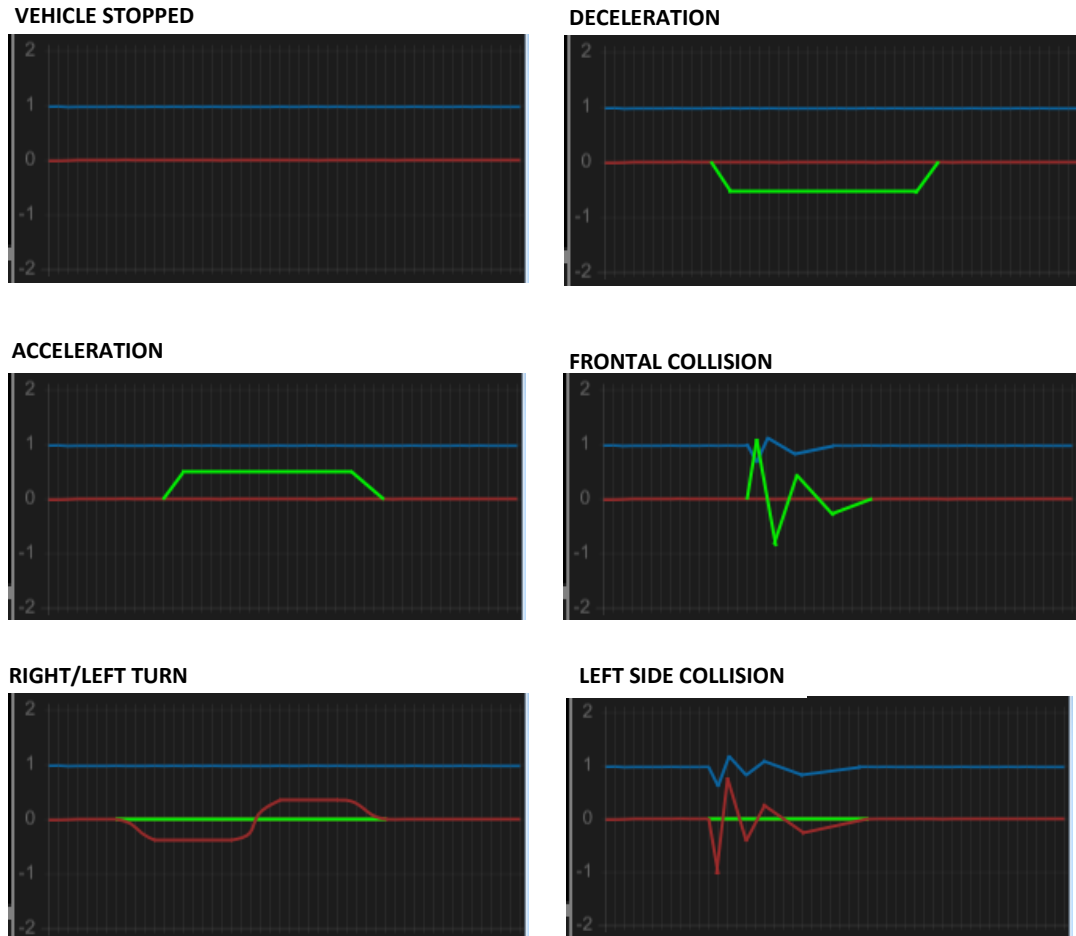

**E X A M P L E S O N L Y**

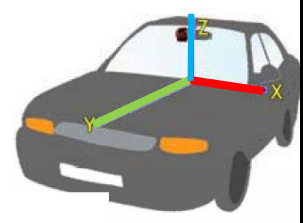

**KEY**

- Z-AXIS** : UP / DOWN MOTION
- X-AXIS** : LEFT / RIGHT MOTION
- Y-AXIS** : FRONT / BACK MOTION

## Notes on G-Force Sensor Settings

Note that X & Y axes are 0 when vehicle is stationary. The Z-Axis is at +1 when vehicle is stationary and on a flat slope, due to the force of gravity. Adjust the g-sensor threshold values in the DVXC4 configuration with this in mind (see page 24). This is a trial-and-error effort, since different types of vehicles will react differently under various road conditions. The values for the Z-Axis must be set above 1, so that it does not record Events while the vehicle is not moving. Under normal driving conditions for an automobile, settings of X= 0.5 G, Y= 0.5G, Z = 1.8 G are recommended as being sufficient to identify driver-behavior issues while being high enough to avoid most unnecessary event-marking caused by potholes or normal braking.

# G-SENSOR Event Examples in DV-Pro5

## Hard Braking

2016/01/19 11:02:22 CH1 720P 30FPS ROSCO

Metadata ADS

Date: Tue, Jan 19 2016  
 Start Time: 11:02:00  
 End Time: 11:03:00  
 DVXC Name: DVXC4-TARY  
 DVXC Serial: 2c8a  
 DVXC Firmware: 60.6.2  
 Driver Name: TARY  
 Time: 11:02:22 AM  
 Speed: 49 MPH  
 Direction: South East  
 Ignition: On

00:00:22

| Evt | G | D | S | P | Date      | Time     | Select | Driver | Vehicle    | File Size | Filename   |
|-----|---|---|---|---|-----------|----------|--------|--------|------------|-----------|--|
|     |   |   |   |   | 1/19/2016 | 10:56:02 |        | TARY   | DVXC4-TARY | 69.18 MB  | 0000000000000460-160119-105802-105700-10U400000002.nvr |
|     |   |   |   |   | 1/19/2016 | 10:57:00 |        | TARY   | DVXC4-TARY | 69.12 MB  | 0000000000000461-160119-105700-105800-10U200200002.nvr |
|     |   |   |   |   | 1/19/2016 | 10:58:00 |        | TARY   | DVXC4-TARY | 69.31 MB  | 0000000000000462-160119-105800-105900-10U200100002.nvr |
|     |   |   |   |   | 1/19/2016 | 10:59:00 |        | TARY   | DVXC4-TARY | 69.23 MB  | 0000000000000463-160119-105900-110001-10U200200002.nvr |
|     |   |   |   |   | 1/19/2016 | 11:00:01 |        | TARY   | DVXC4-TARY | 69.35 MB  | 0000000000000464-160119-110001-110102-10U400000002.nvr |
|     |   |   |   |   | 1/19/2016 | 11:01:02 |        | TARY   | DVXC4-TARY | 69.24 MB  | 0000000000000465-160119-110102-110200-10U400000002.nvr |
|     |   |   |   |   | 1/19/2016 | 11:02:20 |        | TARY   | DVXC4-TARY | 69.40 MB  | 0000000000000466-160119-110200-110300-10U200500002.nvr |
|     |   |   |   |   | 1/19/2016 | 11:03:00 |        | TARY   | DVXC4-TARY | 69.41 MB  | 0000000000000467-160119-110300-110400-10U700100002.nvr |
|     |   |   |   |   | 1/19/2016 | 11:04:02 |        | TARY   | DVXC4-TARY | 68.32 MB  | 0000000000000468-160119-110402-110500-10U400000002.nvr |
|     |   |   |   |   | 1/19/2016 | 11:05:00 |        | TARY   | DVXC4-TARY | 69.19 MB  | 0000000000000469-160119-110500-110600-10U200400002.nvr |
|     |   |   |   |   | 1/19/2016 | 11:06:00 |        | TARY   | DVXC4-TARY | 69.35 MB  | 0000000000000470-160119-110600-110700-10U400000002.nvr |
|     |   |   |   |   | 1/19/2016 | 11:07:01 |        | TARY   | DVXC4-TARY | 20.85 MB  | 0000000000000471-160119-110701-110718-10U400000002.nvr |
|     |   |   |   |   | 1/19/2016 | 11:07:20 |        | TARY   | DVXC4-TARY | 3.17 MB   | 0000000000000472-160119-110720-110747-10U400010002.nvr |

## Hard Turning

2016/02/05 16:40:06 CH1 720P 30FPS ROSCO

Metadata ADS

Date: Fri Feb 5 2016  
 Start Time: 16:40:00  
 End Time: 16:41:00  
 DVXC Name: DVXC4-TARY  
 DVXC Serial: 2c8a  
 DVXC Firmware: 60.6.4  
 Driver Name: TARY  
 Time: 4:40:09 PM  
 Speed: 16 MPH  
 Direction: North West  
 Ignition: On

00:00:09

| Evt | G | D | S | P | Date     | Time     | Select | Driver | Vehicle    | File Size | Filename   |
|-----|---|---|---|---|----------|----------|--------|--------|------------|-----------|--|
|     |   |   |   |   | 2/5/2016 | 16:36:00 |        | TARY   | DVXC4-TARY | 53.67 MB  | 0000000000001410-160205-163600-163700-10U400000002.nvr |
|     |   |   |   |   | 2/5/2016 | 16:37:00 |        | TARY   | DVXC4-TARY | 52.88 MB  | 0000000000001411-160205-163700-163800-10U400000002.nvr |
|     |   |   |   |   | 2/5/2016 | 16:38:00 |        | TARY   | DVXC4-TARY | 53.55 MB  | 0000000000001412-160205-163800-163900-10U400000002.nvr |
|     |   |   |   |   | 2/5/2016 | 16:39:00 |        | TARY   | DVXC4-TARY | 53.56 MB  | 0000000000001413-160205-163900-164000-10U700400002.nvr |
|     |   |   |   |   | 2/5/2016 | 16:40:00 |        | TARY   | DVXC4-TARY | 53.44 MB  | 0000000000001414-160205-164000-164100-10U200400002.nvr |
|     |   |   |   |   | 2/5/2016 | 16:41:00 |        | TARY   | DVXC4-TARY | 53.59 MB  | 0000000000001415-160205-164100-164200-10U400000002.nvr |
|     |   |   |   |   | 2/5/2016 | 16:42:01 |        | TARY   | DVXC4-TARY | 53.63 MB  | 0000000000001416-160205-164201-164300-10U400000002.nvr |
|     |   |   |   |   | 2/5/2016 | 16:43:00 |        | TARY   | DVXC4-TARY | 53.55 MB  | 0000000000001417-160205-164300-164400-10U400000002.nvr |
|     |   |   |   |   | 2/5/2016 | 16:44:05 |        | TARY   | DVXC4-TARY | 53.50 MB  | 0000000000001418-160205-164405-164500-10U400000002.nvr |
|     |   |   |   |   | 2/5/2016 | 16:45:04 |        | TARY   | DVXC4-TARY | 53.44 MB  | 0000000000001419-160205-164504-164600-10U400000002.nvr |
|     |   |   |   |   | 2/5/2016 | 16:46:00 |        | TARY   | DVXC4-TARY | 53.10 MB  | 0000000000001420-160205-164600-164700-10U400000002.nvr |
|     |   |   |   |   | 2/5/2016 | 16:47:00 |        | TARY   | DVXC4-TARY | 53.51 MB  | 0000000000001421-160205-164700-164800-10U400000002.nvr |
|     |   |   |   |   | 2/5/2016 | 16:48:00 |        | TARY   | DVXC4-TARY | 932.32 KB | 0000000000001422-160205-164800-164801-10U400000002.nvr |

# Backing Up Video Files to Your PC (Import)

DV-Pro has a built in “Import” function that creates and automatically organizes a database of video on your local machine/server, limited only by the data storage resources at your disposal.

**Step 1:** Insert SD card into Reader slot or Device and open DV-Pro 5. Video file list will populate. You can choose to import the complete contents of the SD card to the PC or just to import files by Event type, date/time, or by individually selecting files of interest.

**Step 2:** Click on the Import icon (  ) located at the lower right corner of the player screen next to the map. A pop-up “Import” window will then appear. NOTE: If “Source” is blank, click “Change Source” to select the directory of the SD card. Make selections as needed. Click “Import Files” to save the files to the PC.

**Step 3:** The window will show save progress. Do not close the window until all selected files imported.

**Step 4:** When the window confirms “Importing Complete”, click “Close” or click “View Files” button to confirm the files were saved correctly.

**Step 5:** Confirm the desired files were saved to the directory chosen in Step 2.

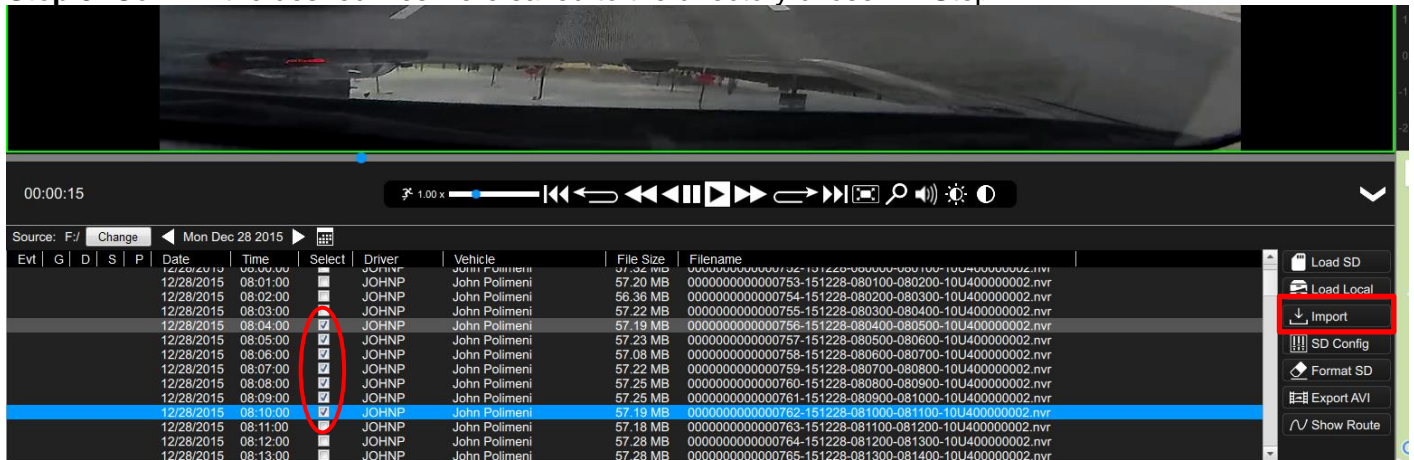

Note: Prior to clicking “Import”, the “cog” icon on the home screen can also be clicked to change the import location.

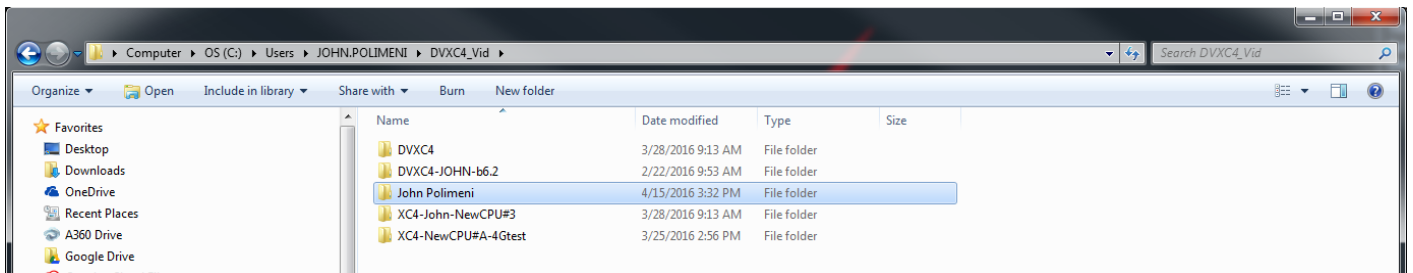
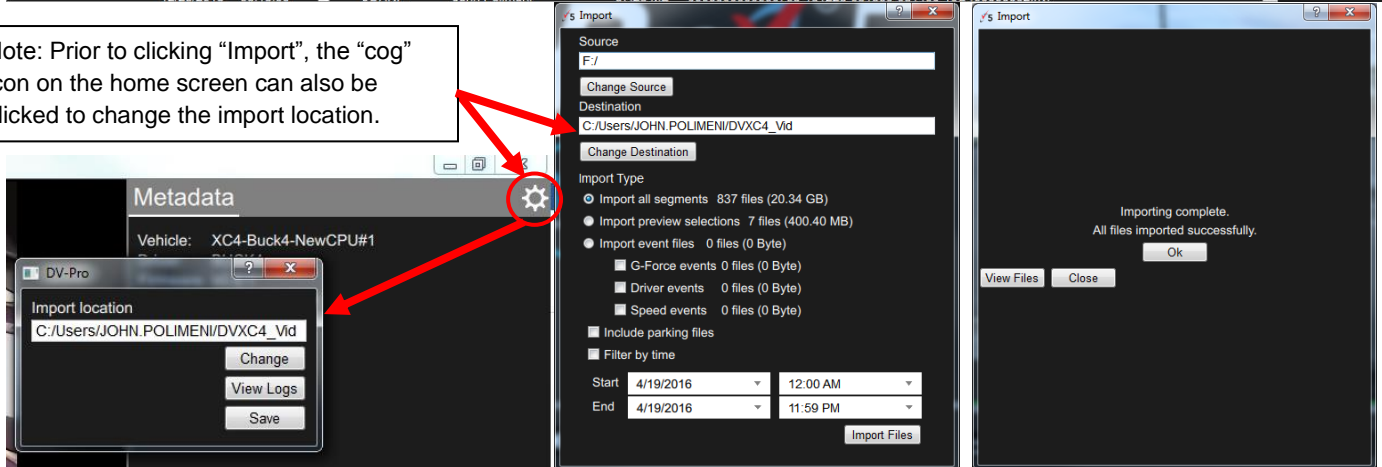



# Conversion of Video To AVI

This function converts a portion of the recorded data into an .AVI file that can be viewed on universal video players such as Windows Media Player, VLC Player, etc. This feature allows sharing of video across multiple platforms via email or any other means of file transfer.

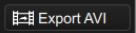
1. In the main player Window, choose the video file(s) of interest using the Select Checkbox. Click the Export AVI button (  ), click “Change” button to select the target directory, and make the desired selections of channels and audio (see right).

**Note:** DV-Pro5 cannot immediately save the .avi files to external media such as an SD Card or USB memory stick, but only to your PC’s hard drive. The AVI file can however be moved to any external media after initial export. Click on Start and conversion will take place.

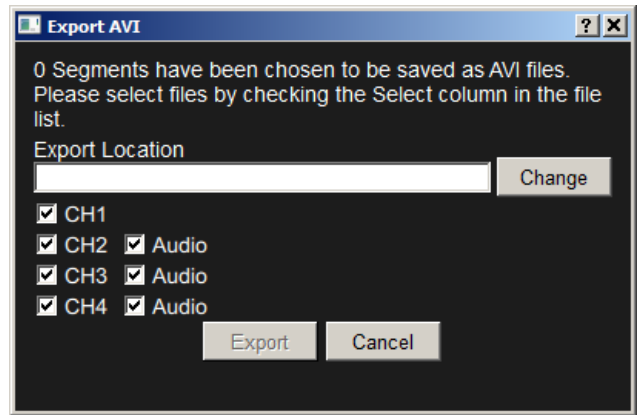

2. The converter will create AVI files and will place them in the desired PC directory. The window will show the progress of file conversion and confirm with a “Conversion Complete” message when done. Click Close, or “View Files” to confirm correct export.

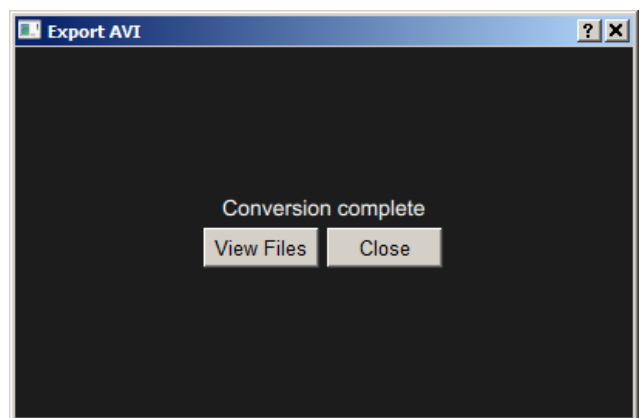

3. If viewing files, click on the AVI file to playback video using a universal player program such as Windows Media Player or VLC Player.

4. You may now move the new .AVI files to any SD card or other external media. You may also email them as attachments, upload via Dropbox or other FTP service, etc.

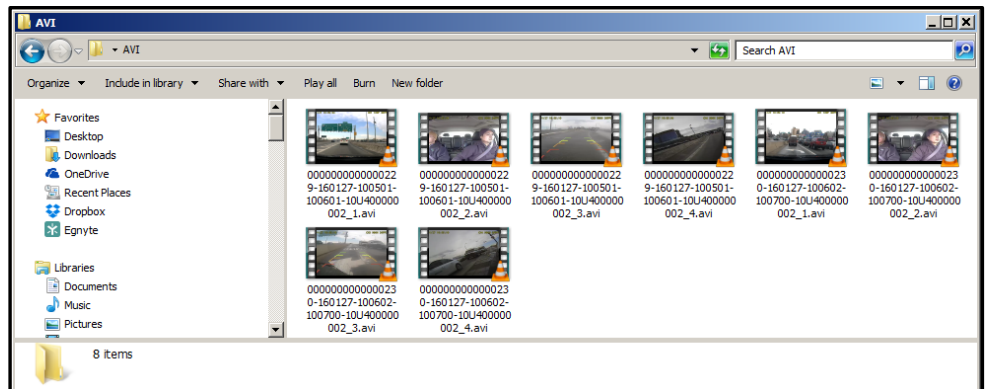

# Vehicle Location Map

The Dual-Vision™ XC4 records GPS data to enable historical review of vehicle location and route. The map coordinates are automatically synchronized with Google Maps®. You may manually re-sync the map by clicking the “Popout” button on the upper right corner of map.

Additionally, one may select various video files using the check boxes, and then click the “Show Route” button in the File Menu Tree. A map window will then appear showing the vehicle’s traversed route in the span of the selected videos, highlighted with a red line.

**NOTE: To use any of these functions, the PC must have an internet connection.**

The screenshot displays the DV-Pro 5 software interface. At the top, four video channels (CH1-CH4) are shown, each with a timestamp of 2016/01/27 10:05:10 and resolution of 960H 30FPS ROSCO. The top-right panel shows metadata for the selected video, including Date (Wed Jan 27 2016), Start Time (10:06:02), End Time (10:07:00), DVXC Name (DVXC4-TARY), DVXC Serial (2c8a), DVXC Firmware (b0.6.3), Driver Name (TARY), Time (10:06:11 AM), Speed (7 MPH), Direction (East), and Ignition (On). Below the metadata is a graph showing X, Y, and Z coordinates over time, with a red arrow pointing to the Y-axis value of -0.10. The bottom-left panel shows a file list with columns for Date, Time, Select, Driver, Vehicle, File Size, and Filename. The bottom-right panel shows a map view with a red line indicating the vehicle's route, and a 'Popout' button in the top right corner.

| Evt | G | D | S | P | Date      | Time     | Select | Driver | Vehicle    | File Size | Filename  |
|-----|---|---|---|---|-----------|----------|--------|--------|------------|-----------|---|
|     |   |   |   |   | 1/27/2016 | 10:00:02 |        | TARY   | DVXC4-TARY | 84.99 MB  | 000000000000224-160127-100002-100100-10U4000000 |
| ✓   |   |   |   |   | 1/27/2016 | 10:01:00 |        | TARY   | DVXC4-TARY | 85.10 MB  | 000000000000225-160127-100100-100202-10U2002000 |
| ✓   |   |   |   |   | 1/27/2016 | 10:02:02 |        | TARY   | DVXC4-TARY | 85.93 MB  | 000000000000226-160127-100202-100302-10U2004000 |
| ✓   |   |   |   |   | 1/27/2016 | 10:03:03 |        | TARY   | DVXC4-TARY | 85.03 MB  | 000000000000227-160127-100303-100401-10U4000000 |
| ✓   |   |   |   |   | 1/27/2016 | 10:04:01 |        | TARY   | DVXC4-TARY | 84.88 MB  | 000000000000228-160127-100401-100501-10U4000000 |
|     |   |   |   |   | 1/27/2016 | 10:05:01 |        | TARY   | DVXC4-TARY | 84.33 MB  | 000000000000229-160127-100501-100601-10U4000000 |
|     |   |   |   |   | 1/27/2016 | 10:06:02 |        | TARY   | DVXC4-TARY | 84.97 MB  | 000000000000230-160127-100602-100700-10U4000000 |
|     |   |   |   |   | 1/27/2016 | 10:07:00 |        | TARY   | DVXC4-TARY | 84.94 MB  | 000000000000231-160127-100700-100800-10U4000000 |
|     |   |   |   |   | 1/27/2016 | 10:08:00 |        | TARY   | DVXC4-TARY | 85.05 MB  | 000000000000232-160127-100800-100902-10U4000000 |
|     |   |   |   |   | 1/27/2016 | 10:09:02 |        | TARY   | DVXC4-TARY | 84.84 MB  | 000000000000233-160127-100902-101000-10U4000000 |
|     |   |   |   |   | 1/27/2016 | 10:10:00 |        | TARY   | DVXC4-TARY | 24.52 MB  | 000000000000234-160127-101000-101017-10U4000000 |
| ✓   |   |   |   |   | 1/27/2016 | 10:10:19 |        | TARY   | DVXC4-TARY | 1.60 MB   | 000000000000235-160127-101019-101028-10U4000100 |
|     |   |   |   |   | 1/27/2016 | 10:11:12 |        | TARY   | DVXC4-TARY | 69.59 MB  | 000000000000236-160127-101112-101200-10U4000000 |

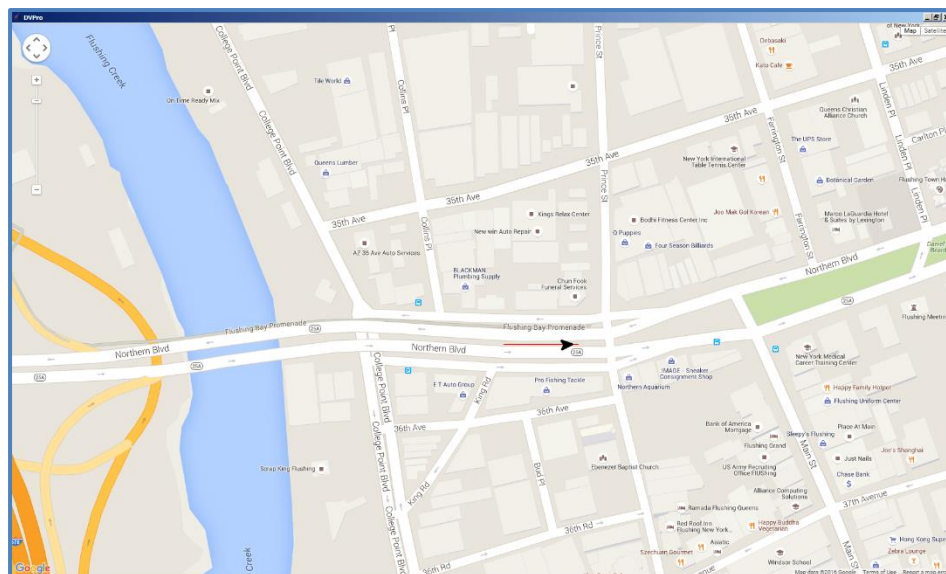

# Format SD Card using DV-Pro5

## **IMPORTANT**

**SD CARD FORMATTING MUST BE DONE USING DV-PRO5 ONLY. USING THE PC'S DEFAULT FORMATTER OR A THIRD PARTY TOOL WILL RENDER THE SD CARD UNUSABLE BY THE DVXC4 RECORDER.**

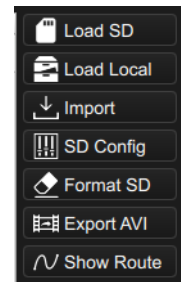

1. Open DV-Pro 5. Select the SD CARD using the “Change” button on the main screen. (NOTE: The SD Card will be automatically recognized if SD Card is inserted before opening DV-Pro5.)
2. Click the “Format SD” menu button in the bottom right corner of the main screen.
3. If you want to keep the current configuration, check the box to save it in the formatted SD card. Otherwise, the contents of the SD card will be completely erased. Click the “Format” button to format the SD card.

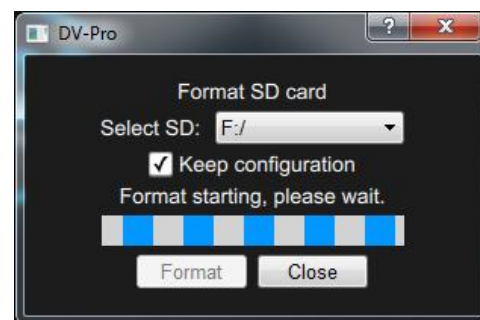

4. When the format is complete, the following screen will appear:

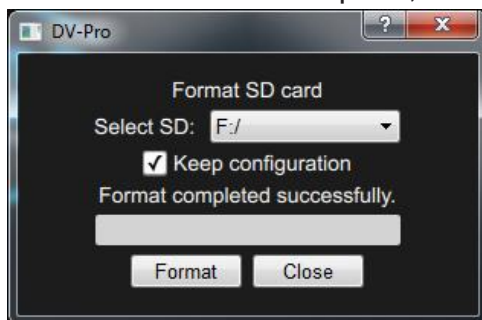

5. If the “Keep configuration” box was checked prior to format, go to “Computer/Removable Disk” and confirm “config.txt” file is still there. You may use the newly formatted card in a Recorder as-is, or use DV-PRO5 to update the configuration if needed.

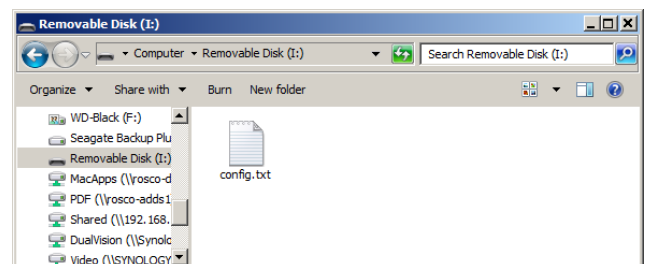

**Close DV-Pro 5. USE THE “EJECT” FEATURE ON YOUR PC PRIOR TO REMOVING THE SD CARD FROM YOUR PC. See page 26. Then see page 14 to re-insert the SD Card into the Dual-Vision™ XC4 Recorder and into the vehicle.**

# SD Card Maintenance

## **IMPORTANT**

Remember to **ALWAYS** turn OFF the vehicle prior to removal of SD Card from Dual-Vision™ XC4 Recorder.

- When parking surveillance mode is OFF, turn ignition off. It is safe to remove the SD card after the Recorder's LCD display turns off.
- If parking surveillance mode is ON, turn ignition off and wait for few seconds until the LCD display begins blinking/dimming. Then press and hold the Drive Event Button for at least 5 seconds. The LCD will show the message "SHUT" and then turn off after a few seconds. **FOLLOW DIRECTIONS ON PAGE 19 TO UNLOCK THE RECORDER AND REMOVE THE SD CARD.**

**Do Not Use** SD Card for any other purpose other than recording with the DVXC4. Using this SD Card for any other purpose or removing the card while the Recorder is powered may cause a fatal error on the SD Card. You will lose important data if SD card is removed without following proper shutdown procedures.

**Recommended: Use the DV-Pro 5 "Import" function to back-up the SD Card's video files onto your PC or other mass storage resources.**

**IMPORTANT:** Rosco recommends formatting the SD Card once every six months to a year, using the DV-Pro5 program, to prevent SD Card errors from accumulating over a long period of time. Periodically formatting SD card using DV-Pro 5 program not cleans up bad sectors in memory and will decrease the possibility of losing or corrupting video files.

Note that upon formatting the SD Card, all existing files will be deleted. Be sure to perform a backup of any important video files and configuration prior to reformatting. After formatting, you may insert the SD card into Dual-Vision™ XC4. The Recorder will automatically write the previously used recording Configuration file to the SD card.

The "DV-Pro5" program and User Manual does not automatically re-install onto the SD Card. If desired, it may be added manually by copying and pasting from another location. New data files will be automatically created as driving resumes.

Consult Rosco or an Authorized Reseller for SD Card compatibility. Not all SD Cards work with the Dual-Vision XC4 Recorder. The following is a list of approved SD Cards which may be purchased from Rosco. This list may be periodically updated without notice.

| SD CARD SIZE | ROSCO PART # | DESCRIPTION  |
|--------------|--------------|--|
| <b>32GB</b>  | <b>DV452</b> | SDHC CARD, 32GB, CLASS 10, PRELOADED W/ MANUAL & DEFAULT CONFIGURATION FILE  |
| <b>64GB</b>  | <b>DV453</b> | SDXC CARD, 64GB, CLASS 10, PRELOADED W/ MANUAL & DEFAULT CONFIGURATION FILE  |
| <b>128GB</b> | <b>DV454</b> | SDXC CARD, 128GB, CLASS 10, PRELOADED W/ MANUAL & DEFAULT CONFIGURATION FILE |
| <b>256GB</b> | <b>DV455</b> | SDXC CARD, 256GB, CLASS 10, PRELOADED W/ MANUAL & DEFAULT CONFIGURATION FILE |

**IMPORTANT: SD Card Reader (USB 3.0)** – The above High Capacity SD cards requires using USB3.0 Compatible SD Card Reader for a faster read/write performance, stability and reliability of reviewing video on DV-Pro5 player software.

# DVCV4 Hardware Technical Specifications

## PRODUCT SPECIFICATIONS

|   |   |  |
|---|---|--|
| <b>Built-in Cameras</b>                             | Two Cameras with CMOS Sensors   |  |
| <b>Camera Viewing Angles</b>                        | Front Camera: D135°x H85° x V55°<br>Interior Camera: D160° x H112° x V80°   |  |
| <b>Video Compression</b>                            | H.264 with CBR (Constant Bit Rate)  |  |
| <b>Technologies used for Enhanced Video Quality</b> | Active anti-blooming and dark sun cancellation, Lens shading and pixel defect correction, Color interpolation & correction, Luminance and color noise reduction, Edge enhancement, Gamma correction, white balance to balance color fidelity & contrast |  |
| <b>Resolution</b>                                   | 720p for windshield view and 960h for cabin interior view camera  |  |
| <b>Audio</b>  | 1CH, Mono in the Interior View Camera<br>Support Ch3, Ch4 cams for audio  |  |
| <b>GPS</b>  | Built-in GPS module w/antenna   |  |
| <b>G-Sensor (X, Y, and Z)</b>                       | Built-in 3D Acceleration G-Sensor   |  |
| <b>Volume</b>                                       | Configurable (Off – 5)  |  |
| <b>Video Quality for Recording</b>                  | Configurable (1-normal to 5-high)   |  |
| <b>Video Frame Rate</b>                             | Configurable (1–30 frames/sec/camera)   |  |
| <b>Memory Card</b>                                  | 32GB SDHC up to 256GB SDXC  |  |
| <b>Operating Voltage</b>                            | 12 VDC ~ 24 VDC   |  |
| <b>Operating Temperature</b>                        | -20°C ~ +65°C (-4°F ~ +149°F)   |  |
| <b>Storage Temperature</b>                          | -40°C ~ +85°C (-40°F ~ +185°F)  |  |
| <b>Size</b>   | W 3.70" x L 4.13" x T 2.0"  |  |
| <b>Weight</b>                                       | 7.5 oz. recorder unit, 5.3 oz. bracket,<br>12.6 oz. recorder unit with bracket  |  |
| <b>Current Consumption @12.8 VDC</b>                | Maximum   | ~1.2 A (4 channels with Wi-Fi and 4G Wireless) |
|   | Operation   | ~450mA (2ch only) ~650mA (4ch)                 |
|   | Parking   | ~400mA (2ch only)                              |
|   | With Wi-Fi  | ~550mA (2ch only), ~700mA (4ch)                |
|   | PDC only  | ~200mA (without Recorder)                      |
|   | OFF/Standby   | ~10mA  |
| <b>Standard Compliance</b>                          | FCC   | Certified Part 15 Subpart B                    |
|   | EMC   | ANSI C63.4-2009                                |
|   | CE  | Pending Approval                               |

# Engineering Drawings

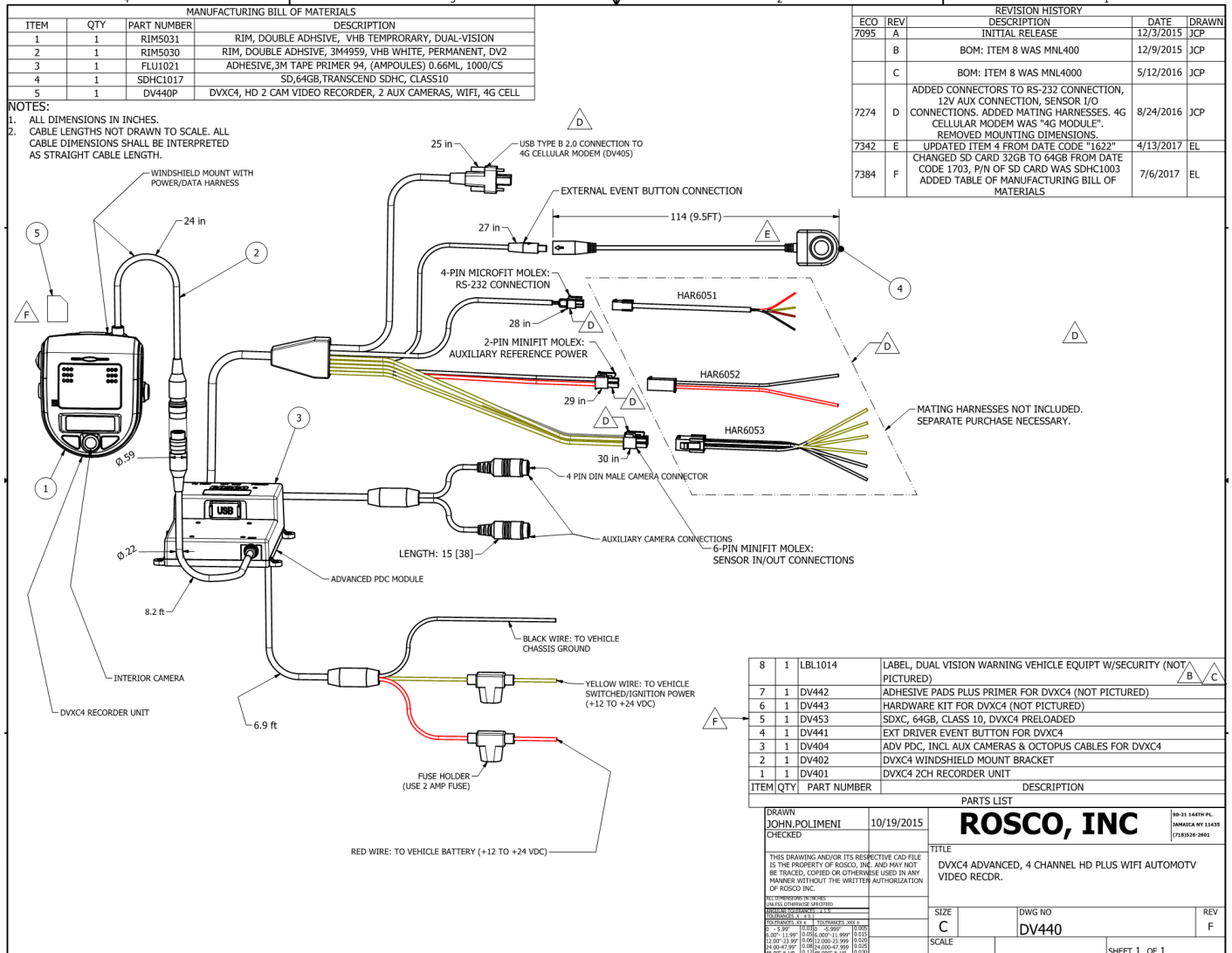

## Application Notes

- AN\_DV440\_STSS1000\_STSC109R\_STSC141.pdf
- AN\_DV440\_STSK4530\_STSC118.pdf
- AN\_DV440\_STSM251\_STSS1000.pdf
- AN\_DV440\_STSK7965\_STSH390\_STSS1000.pdf
- AN\_DV440\_STSK7965\_STSW1001.pdf
- AN\_DV440\_STSM205\_STSW1001.pdf

Application Notes and Installation Instructions are available for resellers & installers upon request. Call Rosco Customer Support or send email to [techsupport@roscovision.com](mailto:techsupport@roscovision.com) for more detail.



# Troubleshooting

|                    | Problem  | Possible Cause  | Corrective Action  |
|--------------------|--|---|--|
| <b>Power</b>       | LCD display is dark.<br>No chime heard upon starting vehicle.                    | No power to Recorder  | Check the power cable connection and fuses   |
| <b>LCD Display</b> | LCD display is faint, but chime heard upon starting vehicle.                     | Low brightness setting  | Open Configuration screen in DV-Pro5 and adjust Backlight Day/Night Settings   |
| <b>Event</b>       | Event icon is constantly lit.  | Constant Events and chimes due to bumps and potholes          | Increase G-Sensor settings based on your vehicle types and needs.  |
| <b>Speed</b>       | Constant chiming   | Speed Event Threshold set too low                             | Increase Speed limit threshold based on your vehicle needs.  |
| <b>GPS</b>         | GPS icon remains unlit while driving, vehicle speed not indicated on LCD display | GPS antenna is not able to acquire satellite signal           | Relocate Recorder and mounting base to position with line-of-sight to sky  |
| <b>LCD Message</b> | ErrX   | Error notices on display                                      | Contact your dealer or Rosco for Assistance  |
| <b>LCD Message</b> | SD_E   | SD Card error<br>No SD Card, SD Card not reading/writing      | Remove and properly insert SD card OR<br>Reformat or replace SD Card   |
| <b>Playback</b>    | Blurry video   | Camera/lens problem<br>OR<br>Low Video Quality Setting        | Make sure Camera/lens is clean and clear of obstructions<br>AND/OR<br>Increase video quality in DV-Pro Configuration   |
| <b>Playback</b>    | Low/Choppy Video Framerate   | Low Frame Rate Setting  | Increase frame rate in DV-Pro Configuration  |
| <b>Playback</b>    | No audio   | Improper software settings in Player or Configuration screens | <b>Configuration</b> - Ch1 has no audio but you can set Audio Volume level for each Ch2, Ch3, Ch4 cameras thru DV-Pro5 configuration menu<br><b>DV-Pro5 Player</b> – adjust Volume Control slider as desired.<br><b>Check speaker settings on PC</b> |
| <b>Speaker</b>     | No chime or loud chime   | Improper setting in DV-Pro5 Configuration Menu                | Adjust the Speaker Volume setting in the DV-Pro5 configuration menu.   |

# AUX Cameras (Optional)

The Dual-Vision™ XC4 is capable of recording video from two extra auxiliary 4-pin (“AUX”) cameras which may be connected to the External Camera ports in the PDC module. Rosco has a full range of cameras available for selection including both rugged and compact, license plate cameras, integrated brake light, side view, bumper/flush mounted, rear hatch, and interior dome surveillance cameras.

Contact Rosco or an authorized dealer for a list of compatible 4-pin cameras. The following high-definition (960H) cameras are recommended:

| Part Number     | Description   |   |
|-----------------|---|---|
| <b>STSC167</b>  | Side View Camera, Right Front/Left Rear, Silver, W/ Night Vision, 960H                  |    |
| <b>STSC168</b>  | Side View Camera, Left Front/Right Rear, Silver, W/ Night Vision, 960H                  |   |
| <b>STSA1006</b> | 5 degree adaptor, silver, for STSC167, STSC168  |   |
| <b>STSC169</b>  | Internal Dome Camera, Black, W/ Night Vision & Audio , 960H, 0° and 25° Mounts Included |   |
| <b>STSA1007</b> | 0 degree adaptor, black, for STSC169  |   |
| <b>STSA1009</b> | 25 degree adaptor, black, for STSC169   |   |
| <b>STSC170</b>  | Internal Dome Camera, White, W/ Night Vision & Audio , 960H, 0° and 25° Mounts Included |   |
| <b>STSA1010</b> | 0 degree adaptor, white, for STSC170  |   |
| <b>STSA1011</b> | 25 degree adaptor, white, for STSC170   |   |
| <b>STSC141</b>  | Backup Camera, Silver, W/ Night Vision & Audio  |  |



# Spare Parts

| Rosco Sales Part Number     | Description  |
|-----------------------------|--|
| <b>DV440 KIT (Included)</b> |  |
| DV401                       | Dual-Vision™ XC4 2Ch Recorder Unit Only                          |
| DV402                       | Dual-Vision™ XC4 Windshield Mount Bracket Only                   |
| DV404                       | Dual-Vision™ XC4 PDC Only  |
| DV441                       | Dual-Vision™ XC4 External Driver Event Button                    |
| DV442                       | Dual-Vision™ XC4 Adhesive Pads plus Primer                       |
| DV443                       | Dual-Vision™ XC4 Hardware KIT for DV420 or DV440                 |
| DV453                       | SDXC Card, 64GB, CL10, PRELOADED                                 |
| <b>MODEMS (Optional)</b>    |  |
| DV405                       | 4G LTE Cellular Modem, w/SIM for US                              |
| SIM1002                     | Verizon SIM card for DV405                                       |
| DV418                       | 4G LTE Cellular Modem, LT1002 w/SIM for US                       |
| DV422                       | 4G LTE Cellular Modem, EM1000T-NA wo/SIM for Canada              |
| DV406                       | USB Wi-Fi Modem w/PDC mount Cover & Hardware                     |
| <b>ANTENNAS (Optional)</b>  |  |
| DV408                       | 4G LTE Cellular Windshield Mount Antenna for DV405, DV418, DV422 |
| DV407                       | Wi-Fi MIMO Windshield Mount Antenna for DV406                    |
| DV412                       | Wi-Fi MIMO Screw Mount Antenna for DV406                         |
| DV415                       | Wi-Fi MIMO Antenna Extension Cables (2) for DV412                |
| <b>SD CARDS (Optional)</b>  |  |
| DV452                       | SDHC Card, 32GB, CL10, PRELOADED                                 |
| DV453                       | SDXC Card, 64GB, CL10, PRELOADED                                 |
| DV454                       | SDXC Card, 128GB, CL10, PRELOADED                                |
| DV455                       | SDXC Card, 256GB, CL10, PRELOADED                                |
| <b>HARNESSES (Optional)</b> |  |
| HAR6051                     | Mating Harness for RS232 port on PDC                             |
| HAR6052                     | Mating Harness for RS232 port 12Volt power on PDC                |
| HAR6053                     | Mating Harness for Sensor I/O Ports on PDC                       |

# Commercial Warranty

We warrant that all ROSCO mirror, camera, sun visor, and electronic vision products are free from defects in workmanship and materials for a period of ONE (1) YEAR from the date of receipt of the product. During the warranty period, we agree to provide a replacement for (or at our option, repair) the ROSCO product and/or any one or more component parts of a ROSCO product which malfunctions under normal use and service.

Upon discovering a defect, the customer must contact ROSCO for a return authorization and then must return the product, and/or component part, together with proof of date of receipt of the product, to ROSCO INC. 144-31 91st Ave. Jamaica, New York 11435. The customer and not ROSCO will be responsible for the payment of all removal, installation and transportation charges for return of defective products or components to ROSCO. Transportation charges for such return must be prepaid. The repaired or replaced equipment will be returned to the customer with transportation charges prepaid by ROSCO. Replacement (or repaired) products and/or component parts are warranted only for the unexpired term of the original warranty.

This warranty does not cover defects caused by neglect, misuse, incorrect application, incorrect installation, water damage, vehicle wash facilities, alteration or repair in any manner outside ROSCO's factory. Damage caused by the return shipment due to inadequate packaging or mishandling will not be covered. If the alleged defect is due to any of these causes, the customer will be advised of the findings and asked what action is to be taken. If ROSCO is requested to repair the product, a repair charge estimate will be prepared and the customer's written permission (purchase order, repair, etc.) will be necessary to proceed with the repair of the product and/or component part. Transportation charges for such returns will be the responsibility of the customer.

This warranty may not be expanded by oral representation, written sales information, and drawings or otherwise. Repair or replacement is the exclusive remedy for defective products under this warranty. This warranty is expressly in lieu of all other warranties, including any implied warranty of merchantability or any implied warranty of fitness for a particular purpose on any ROSCO product. ROSCO shall not be liable for any consequential or incidental damages for breach of any express or implied warranty on any ROSCO product.

